

≡ Official Monthly Publication of the Society for Information Display

# INFORMATION DISPLAY

July & August 1987  
Vol. 3, No. 7

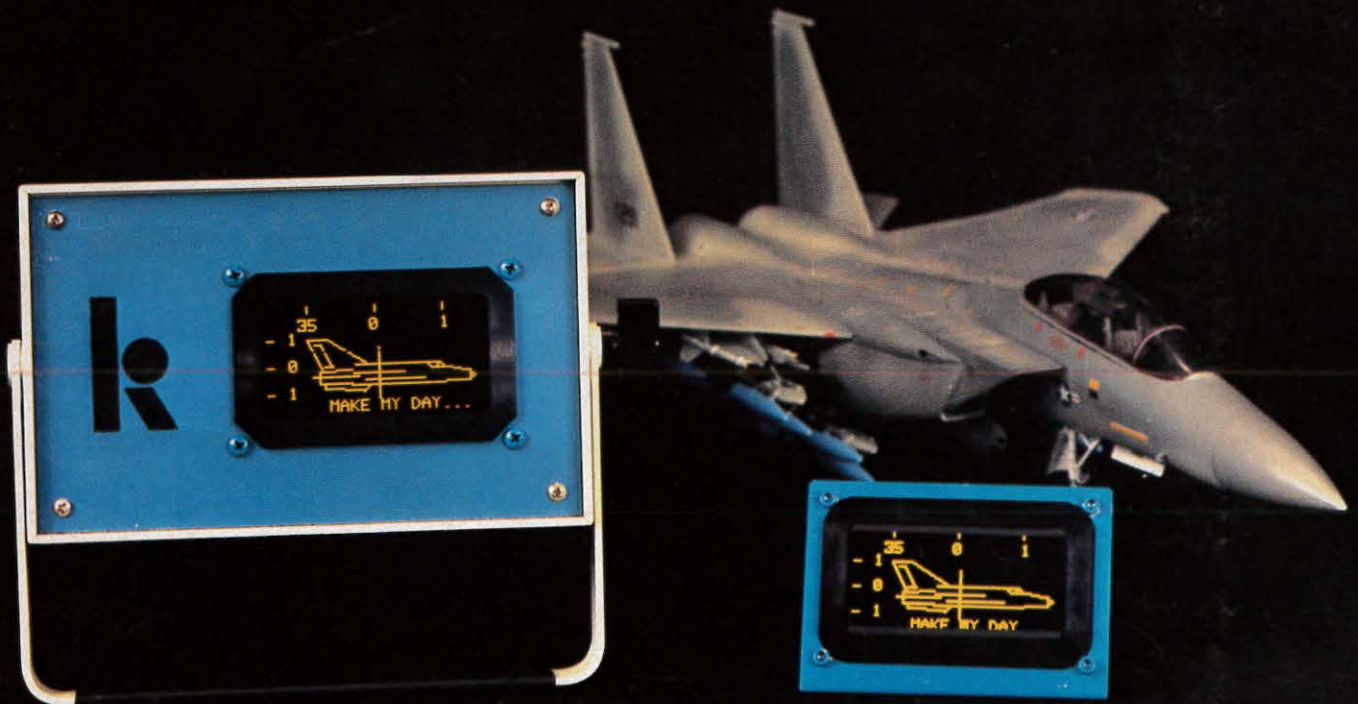

Matrix circuits  
Public information systems  
Company profile: TFD, Inc.  
SID '87 overview

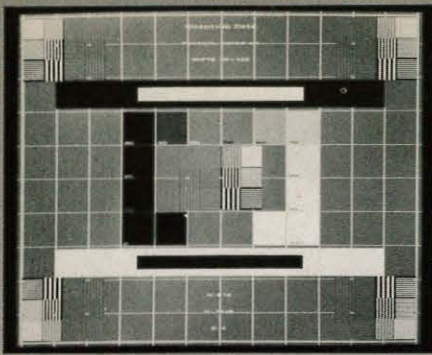

SMPTE RP-133

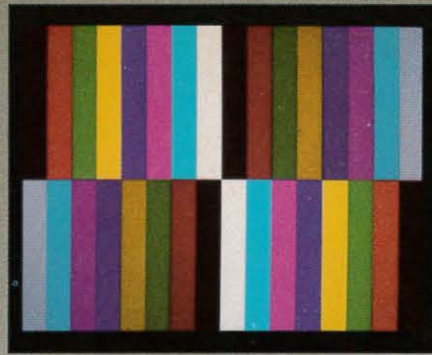

Color Bars

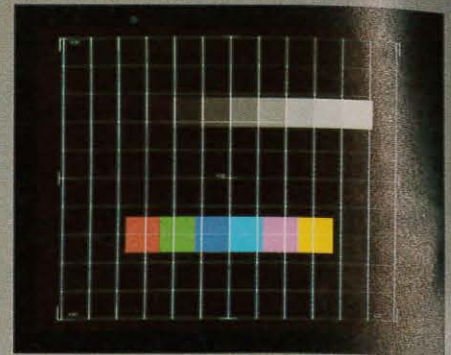

Signal Setup

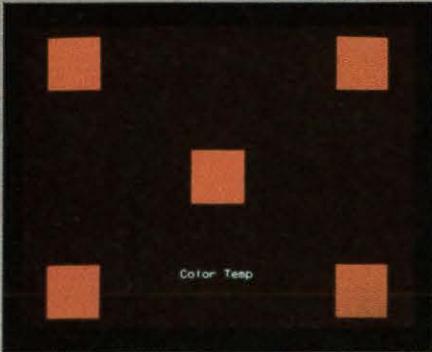

Color Temperature

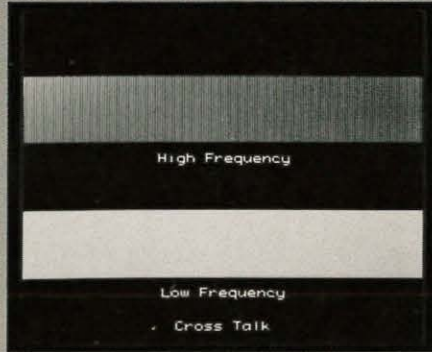

Cross Talk

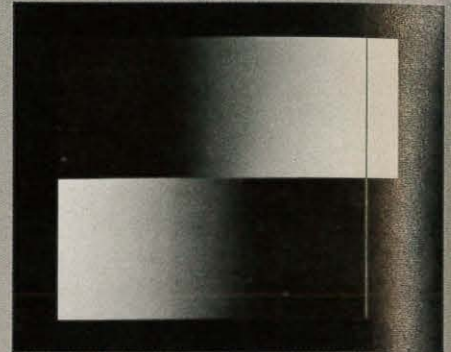

256 Level Gamma Pattern

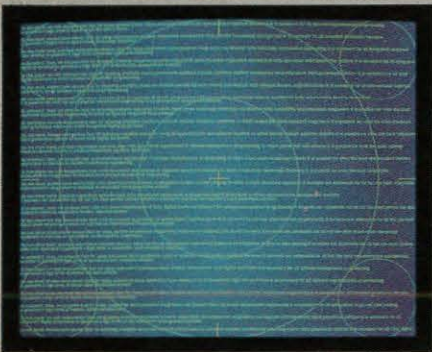

Text with Circle

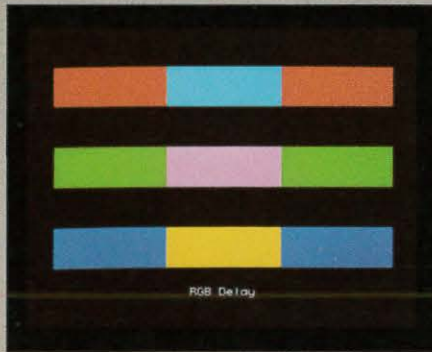

RGB Delay

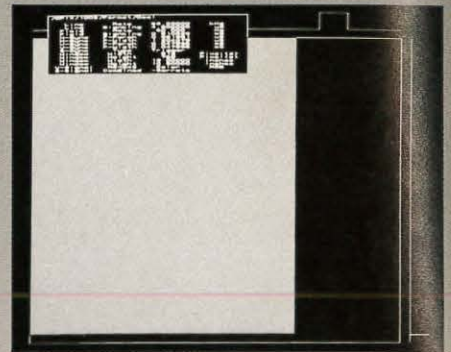

Timing

# THESE PROBLEM SOLVING PATTERNS ARE YOURS AT THE TOUCH OF A BUTTON.



### The OPIX™ Imager:

- 200 MHz analog
- 256 colors or gray scales
- Standard or user-defined patterns
- Battery backed-up memory

The OPIX™ Imager carries 56 built-in Instant-Expert™ test patterns that allow anyone to perform sophisticated diagnostic and correlation tests from day one. It's the only signal generator on the market that offers this capability. And you can design your own tests. Or build off the Instant-Expert patterns by copying a test pattern on disk and modifying it.

The possibilities are endless. The results as exacting as your video parameters require. Do "what if" experiments. Precision test your monitor specifications when hardware logic is still weeks away. Store and recall design specifications that have been out of production for years. You can do it all with the OPIX Imager. Why settle for less? Get the OPIX Imager and bring your video testing to a point of performance you can trust.

For technical data, or a hands-on demonstration contact: QUANTUM DATA, 2111 Big Timber Road, Elgin, IL 60123. Phone: (312) 888-0450 FAX: (312) 888-2802 Telex 206725

See us at SIGGRAPH '87—BOOTH #1316



NO. 4  
IN A SERIES

**Panasonic®** THE Image  
Makers

# PRESENT A CAST OF THOUSANDS.

WITH 15" MONOCHROME PICTURE TUBES

Available with  
optional external  
anti-glare panels

Nominal line  
width (<.2mm)



Uni-potential focus  
lens gun (UPF)

110°, 29mm

Displaying over 6000 characters at once makes our 15" monochrome tube a word processor's dream. Moreover, it offers a host of features including those shown.

From Panasonic...the Image Makers. For more information, contact: Panasonic Industrial Company, Computer Components Division, One Panasonic Way, Secaucus, NJ 07094. Mail Stop 4B5. (201) 348-5278.

**Panasonic**  
Industrial Company

Circle no. 2

# How do your displays measure up?



Vacuum fluorescent and electroluminescent displays courtesy of IEE.

CRT CAD/CAM display courtesy of VG Systems

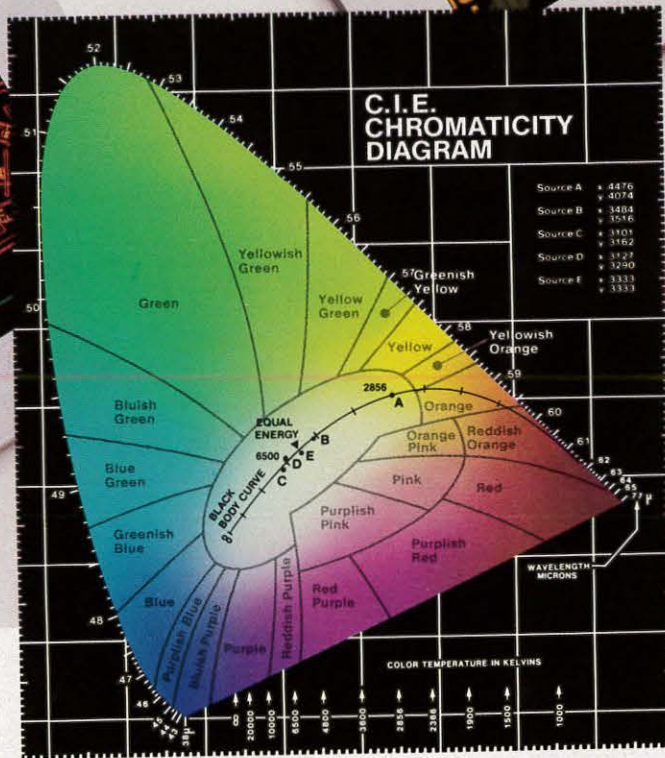

## We can tell you in seconds.

High technology instrumentation for spectroradiometry, photometry and colorimetry:  
 Pritchard® spectral and spatial scanning SpectraRadiometer™ systems.  
 SpectraScan® fast spectral scanning SpectraRadiometer systems.

### PHOTO RESEARCH®

The Light Measurement People™

Division of Kollmorgen Corporation

3000 No. Hollywood Way, Burbank, CA 91505 (818) 843-6100 FAX (818) 846-7687 TLX 69-1427 Cable SPECTRA

AUSTRALIA QUENTRON OPTICS PTY LTD., Ph. 08-223-6224 • CANADA OPTIKON CORPORATION, Ph. 519-885-2551 • FRANCE INSTRUMAT SA, Ph. 1-69 28 27 34 • HOLLAND INTECHMIJ BV, Ph. 020-56-96-611 • WEST GERMANY OPTTEMA ENGINEERING GmbH, Ph. (02122) 67352 • JAPAN KYOKKO TRADING COMPANY, Ph. 03-586-5251 • U.K. MICRON TECHNIQUES LTD., Ph. 0202-841261 • INDIA PHOTONICS INTERNATIONAL, Ph. 366665 • ISRAEL DELTA FILM LTD., Ph. 052-521874 • ITALY ELETTRONUCLEONICA Ph. 4982451 • SWEDEN SAVEN AB, Ph. 08-7921100 • EUROPEAN HEADQUARTERS LUZERN, SWITZERLAND, PHOTO RESEARCH, Ph. 041-31-6194

# INFORMATION DISPLAY

JULY & AUGUST 1987  
VOL. 3, NO. 7

Cover: Matrix circuits are used in electroluminescent devices such as these TFEL flat panels from Kollsman Instrument Co. (page 10)

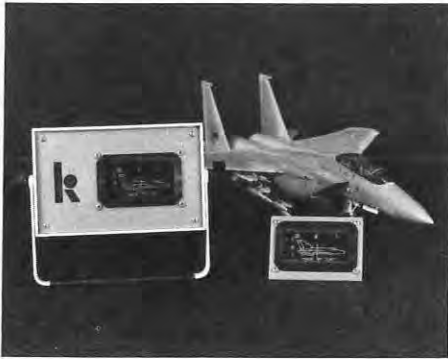

## Next Month in Information Display

- Miniature CRTs
- 3D hard copy
- Industry directory

- 5 Editorial
- 7 President's Message
- 10 Row-to-column impedance of an  $N \times M$  matrix circuit  
*A method is given for expressing the row-to-column impedance variation in matrix circuits used in electroluminescent displays and imagers.*  
*Howard C. Nedderman*
- 12 Company profile: Thin Film Device  
*Our case study of a successful startup in the electronics industry holds some lessons for others who may be long on talent but short on capital.*  
*Ted Lucas*
- 14 Sharing information with the public via IPIS  
*Within the next decade, residents of Singapore will have access to a public information system that will provide its "infoware" to subscribers via intelligent workstations.*  
*Ifay F. Chang*
- 17 You had to have been there. . .  
*Here is some of what you missed if you missed SID '87.*
- 18 Patents
- 21 Have You Read?
- 23 New Products
- 30 Chapter Notes
- 31 Calendar
- 34 Call for Awards Nominations: 1988
- 36 Index to Advertisers



## Our smallest performer gives a brilliant display.

Among special purpose cathode ray tubes, the Hughes Model H-1401 one-half inch tube for helmet-mounted displays outclasses and outsells any similar tube in the industry. Its high brightness and fine resolution characterize our entire line. Hughes is the leader in the design and production of special purpose CRTs—a leadership position maintained by ongoing research and development that sets industry standards for innovation and refinement in CRT technology.

Hughes special-purpose CRTs range in size from one-half-inch diameter to thirteen inch diagonals. They serve avionics, ground vehicles, manportable displays, helmet-mounted displays and high-performance commercial applications such as phototypesetting and medical research.

Hughes has one of the world's finest engineering and technical facilities devoted to CRT production. High manufacturing and testing standards result in the production of tubes of consistent performance, outstanding brightness and resolution factors, low power consumption and high reliability.

For total CRT capability—off the shelf or custom—look to Hughes. You are invited to examine our facilities and

discuss your exact requirements. Call (619) 931-3587 or write: Hughes Aircraft Company, 6155 El Camino Real Carlsbad, CA 92009



*Model 1401, actual size.*

Circle no. 4

**HUGHES**  
AIRCRAFT COMPANY

**Managing Editor:** Hildegard Hammond  
**Technical Editor:** J. Frances Tindall  
**Contributing Editors:** Ted Lucas,  
Ronald Cohen  
**Departments Editor:** Lynne A. Henderson  
**Art Director:** Hildegard Hammond  
**Advertising Manager:** Jay Morreale

**Editorial Advisory Board**

Dr. Ifay F. Chang, Chairman  
*Director of Research*  
*Institute of Systems Science*  
*National University of Singapore*  
Dr. Frederick J. Kahn  
*Vice President*  
*Greyhawk Systems, Inc.*  
Koh-Ichi Miyaji  
*Professor*  
*Shibaura Institute of Technology*  
Jan Rajchman  
*Consultant*  
Aron Vecht  
*Director*  
*Phosphor Consultants*

INFORMATION DISPLAY (ISSN 0362-0972) is published monthly for the Society for Information Display by Palisades Institute for Research Services, Inc., 201 Varick Street, New York, NY 10014; David Slater, Chief Executive Officer; Leonard H. Klein, President; Harold R. Summer, Vice President; Hildegard Hammond, Secretary; Laura Mangone, Treasurer.

EDITORIAL AND BUSINESS OFFICES: Palisades Institute for Research Services, Inc., 201 Varick Street, New York, NY 10014; telephone 212/620-3371. Send manuscripts to the attention of the Editor, ID.

WEST COAST SALES OFFICE: c/o Ted Lucas, P.O. Box 852, Cedar Glen, CA 92321; telephone 714/337-6627.

SID HEADQUARTERS, for correspondence on subscriptions and membership: Society for Information Display, 8055 West Manchester Avenue, Suite 615, Playa del Rey, CA 90293; telephone 213/305-1502.

SUBSCRIPTIONS: Information Display is distributed without charge to those qualified and to SID members as a benefit of membership (annual dues \$35.00). Subscriptions to others: U.S. & Canada: \$36.00 one year, \$64.00 two years, \$90.00 three years, \$3.00 single copy; elsewhere: \$72.00 one year, \$128.00 two years, \$180.00 three years, \$6.00 single copy.

PRINTED by Sheridan Printing Company, 1425 Third Avenue, Alpha, NJ 08865. Third-class postage paid at Alpha, NJ.

POSTMASTER: Send address changes to Society for Information Display, 8055 West Manchester Avenue, Suite 615, Playa del Rey, CA 90293.

PERMISSIONS: Abstracting is permitted with credit to the source. Libraries are permitted to photocopy beyond the limits of the U.S. copyright law for private use of patrons, providing a fee of \$2.00 per article is paid to the Copyright Clearance Center, 21 Congress Street, Salem, MA 01970 (reference serial code 0362-0972/87/\$2.00+\$0.00). Instructors are permitted to photocopy isolated articles for noncommercial classroom use without fee. This permission does not apply to any special reports or lists published in this magazine. For other copying, reprint or republication permission, write to Society for Information Display, 8055 West Manchester Avenue, Suite 615, Playa del Rey, CA 90293.

Copyright © 1987 Society for Information Display. All rights reserved.

Some editorials, though they don't actually write themselves, do fall into place easily; others take innumerable drafts and never do turn out quite right. The one for this issue borders on a worst-case scenario. In the June issue we foolishly promised an article giving an overview of SID '87—foolishly, because any meaningful technical overview would have been overkill in *Information Display*. March's *ID* gave an excellent preview of SID '87, and each subscriber received an advance copy of the entire program. We simply decided we should not spend four to six pages in *ID* trying yet again to distill five very full days of a technical conference. Some sort of wrapup story seemed to be in order though, so we plucked a few asides about New Orleans from various editorial drafts, elaborated on them, and ended up not with a proper article, but with yet another editorial, and an overly long one at that. Trimmed down, it could have been run here, but that would have given short shrift to this combined July/August issue. So, back to the drafts (which, fortunately, are jotted down on scraps of paper while riding on the subway or done at home on a typewriter, not sent to the electronic hereafter on the word processor at the office). Because this is a combined issue, consider this your August editorial. Your July one appears on page 17.

Our July/August *ID* focuses on electroluminescent displays. In his article Howard Nedderman, though offering no new physics or device technology, does cover a loose end in display circuit analysis that should prove of interest to persons working in the field. Of more general interest is Ted Lucas's business profile of Thin Film Device, Inc., a startup electro-optical device company.

In our fourth article Ifay Chang outlines the research he is directing in Singapore toward developing an intelligent public information system. Those of you who enjoyed Abel Farnoux's keynote address at SID '87 will be particularly interested in reading more about this emerging field, but all of us need to consider this visionary view of the information industry in the future and its importance to the information display business.

Thanks again to the indefatigable Howard Funk and his willingness to scour databases quickly and minutely, we are working on an Industry Directory for September's *ID*. We will have more to say about it all then. In only *one* editorial.

# INTERESTED IN A VIDEO GENERATOR?

*Take This "Test" To Make A Better Buying Decision.*

	YES	NO
1. Do you want to display at least 100 levels of gray scales simultaneously at the top speed of your video generator?	<input type="checkbox"/>	<input type="checkbox"/>
2. Do you want to display the seven color bars simultaneously at the top speed of your video generator?	<input type="checkbox"/>	<input type="checkbox"/>
3. Do you want to set the analog level of your video output to +/ - 50% of .7V into 75Ω?	<input type="checkbox"/>	<input type="checkbox"/>
4. Do you need horizontal/vertical timing setting accurate enough to give you what you select — not just a "goal"?	<input type="checkbox"/>	<input type="checkbox"/>
5. Do you need completely independent dot-clock control?	<input type="checkbox"/>	<input type="checkbox"/>
6. Do you want to edit & store up to 100 programs and setups from the front panel of your video generator without an external disk drive?	<input type="checkbox"/>	<input type="checkbox"/>
7. Do you want individual pixel-by-pixel control for patterns from the front panel?	<input type="checkbox"/>	<input type="checkbox"/>
8. Do you want to use your PC to control the video generator, design your own test routines and store it all on a floppy disk?	<input type="checkbox"/>	<input type="checkbox"/>

*...and if your answers are predominantly "Yes" one of the following Video Generators is the right choice:*



**120 MHz**  
**ASTRO VG-811**



**200 MHz**  
**ASTRO VG-809S**



**400 MHz**  
**ASTRO VG-850**

Call (408) 720-8877 — for a demo.

2934 Corvin Drive, Santa Clara, California 95051 ■ Telephone (408) 720-8877

© 1987, Test & Measurement Systems, Inc.

**TEAM**  
systems

Test & Measurement Systems, Inc.



### Executive Committee

President: J.A. van Raalte  
Vice President: L. Tannas, Jr.  
Treasurer: W. Goede  
Secretary: P. Pleshko  
Past President: I.F. Chang

### President's Advisory Council

B. Lechner, Chairman  
T.V. Curran, W. Good, A. Kmetz, P. Pleshko,  
I. Reingold, H.G. Slottow

### Regional Directors

Minneapolis/St. Paul: R. Jamieson  
Canada: J. Wright  
Dayton: R. Holmes  
Delaware Valley: S. Filarsky  
New England: T. Cheek  
Mid-Atlantic: A. Lakatos  
Bay Area: H. Sherman  
Los Angeles: R.C. Knepper  
San Diego: R.E. Thoman  
Japan: M. Ashikawa  
U.K. & Ireland: A. Woodhead  
European: C.J. Gerritsma

### Committee Chairmen

Academic: L. Weber, L. Todd, Jr.  
Archives/Historian: R.C. Knepper  
Bylaws: A. Silzars  
Chapter Formation: A. Lakatos, C.J. Gerritsma  
Conferences  
IDRC—R. Durbeck  
Symposium—T. Credelle  
Definitions & Standards: A. Kmetz  
Honors & Awards: W. Howard  
Intersociety: H.L. Funk  
Memberships: R. Feigenblatt  
Nominations: I.F. Chang, G. Carroll, T. DuPuis  
Publications: P. Heyman  
Proceedings Editor: S. Sherr  
Information Display Editor: J. F. Tindall  
Publicity: J. Price  
Special Technologies  
Workstations—P. Pleshko  
Hard Copy—W. Lloyd

### Chapter Chairmen

Bay Area: G. Carroll  
Canada: A. Moffat  
Dayton: W. Watkins  
Delaware Valley: R. Seifert  
Japan: C. Suzuki  
Los Angeles: P. Baron  
Mid-Atlantic: R. Feigenblatt  
Midwest: J. Markin  
Minneapolis/St. Paul: V. Born  
New England: M. Silverstein  
San Diego: J. Lipscombe  
UK & Ireland: M. Green

### Office Administration

National Office Manager: Bettye Burdett

---

### Society for Information Display

8055 West Manchester Avenue, Suite 615  
Playa Del Rey, CA 90293  
213/305-1502

## president's message



really not correct.

Unless you have experienced this month-long event you may not understand why I call it unique. It is unique partly because it represents the longest regular cycle in the insect world; the larvae live underground for 17 years, feeding on plant-roots, and developing through five different stages, before re-emerging with the regularity of Halley's Comet. An amazing number of frightening-looking, but otherwise-harmless, insects tunnel out of the ground and generate a mating call that cannot be described adequately, other than to say that it makes so much noise that it is hard to carry on a conversation outdoors at times.

The most fascinating aspect of the cicadas is the regularity of their cycle. Thus one cannot help wondering what will happen by the time they re-appear, what will the world be like, where will we be, what will we be doing? Seventeen years ago, when song-writer Bob Dylan received an honorary degree from Princeton University, he wrote a song about the cicadas. Similarly influenced, my father dedicated a poem to his then-newborn grandson wondering where he would be today; he is now a young man of 17.

Still, you may wonder why I mention cicadas in this column. Well, as I said, they are here and hard to ignore. But also, they led me to think about the year 2004 when the cycle will start once again. I may be retired by then. Undoubtedly, many unforeseen technical advances will have taken place, significant new developments will have occurred in many countries, and the centers of technology and industrial production will have shifted dramatically. I mostly wish for a world at peace where our children and grandchildren can enjoy life and find opportunities as rich as ours. Seventeen years is a long time—much can happen and we can all contribute to making the right things happen.

Returning briefly from my philosophical mood to more timely matters, I would like to remind you that the next IDRC, Eurodisplay '87, will take place in London from September 15–17. This promises to be another exciting conference; the programs will be in the mail shortly and I hope you will all be able to join us in London this fall.

Sincerely,



### UCLA film archive receives laser disc grant

The UCLA Film and Television Archive has received a \$30,000 grant from the John D. and Catherine T. MacArthur Foundation. The grant will support research and development into applications of interactive laser disc technologies for the enhancement of visual literacy. Under the direction of archive director Robert Rosen and UCLA film professor Steve Mamber, the newly established program, "The Interactive Technologies Analysis Project," will use laser disc players interfaced with personal computers to produce test discs and software in a range of areas. The project will develop applications of these new technologies in teaching, research, popular education, and improved access to archival materials.

### NCGA graphics competition

The National Computer Graphics Association is calling for entries for its 1988 International Computer Animation Competition. Categories are: *Professional*—broadcast computer graphics; corporate logos; television commercials; corporate communication computer graphics; music videos; research computer graphics; science and industry computer graphics; theatrical motion picture graphics; and non-commercial films. *Non-Professional*—secondary/undergraduate and graduate/faculty.

First-place winners will receive their awards at the NCGA Awards and VideoGala Dinner on March 22, during NCGA '88 in Anaheim, CA. Entries must have been completed after January 1, 1987, and received at NCGA no later than

5:00 p.m. EST on December 1, 1987. Write NCGA, 2722 Merrilee Dr., Suite 200, Fairfax, VA 22031. 703/698-9600.

### TEAM and Seikosha sign agreement

TEAM Systems has signed a new distribution agreement with Seikosha Co., Ltd. TEAM will focus on marketing Seikosha's video printers into the video, microwave, research, and other high technology fields that require quality products and extensive engineering support and assistance. TEAM Systems is headquartered at 2934 Corvin Drive, Santa Clara, CA 95051. 408/720-8877. Seikosha Co., Ltd., is headquartered at 10080 N. Wolfe Road, SW3/249, Cupertino, CA 95014. 408/446-5820.

MINOLTA METERS THE MEASURE OF EXCELLENCE

© 1987 Minolta Corporation

## MINOLTA SOLVES THE PROBLEMS OF BALANCING YOUR MONITORS.

You'll know your colors are lined up perfectly when you adjust your computer monitors, TV sets or video projectors with Minolta's remarkable TV-Color Analyzer II.

No matter which white standard or reference color you input, Minolta gives you precise measurements in easily readable digital display. Plus, there are 3 ten-segment bar graphs to clearly show the nature of any deviations.

And the Color Analyzer is just one of Minolta's full line of light and color measurement instruments. For more information, including our 21 page booklet "Precise Color Communications," please call (201) 825-4000 or write: Minolta Corporation Industrial Meter Division, 101 Williams Drive, Ramsey, NJ 07446.

Because, on balance, the more information you have the better. **ONLY FROM THE MIND OF MINOLTA.**



TV-COLOR ANALYZER II  
Circle no. 6



MINOLTA

# Not all CRTs are created equal.

Equality is an appealing concept.  
But not in CRTs.

Because in certain demanding applications, most notably in photo-recording, an ordinary CRT often will not be able to meet the required specifications.

That's when you'll want the enhanced performance of a Litton tube. And the freedom it gives you from typical CRT problems.

#### **Freedom from blemishes.**

In medical imagery, a blemish or false shadow can be a life or death matter. To produce the most blemish-free screens available, we do all fabrication in a total clean room environment using exclusive phosphor deposition techniques.

**Freedom from uneven color distribution.** In color recording and film scanning, evenness of color is crucial. Litton is the only CRT manufacturer to develop a homogeneous, broad-band phosphor mix. This creates an absolutely even, full-color image without color hot spots.

**Freedom from poor resolution.** In typesetting, equipment has been built that can project an entire magazine page from a 7-inch tube onto a magazine-sized piece of film with razor sharp resolution. That's because our monochrome screens are finer grained than the typical CRT..

and because we offer the smallest spot size available.

We offer fiber optic face plate CRTs with high optical coupling efficiency.

And a real tour de force—a multi-beam gun technology capable of extremely high data recording rates and display density.

Our full line of recording CRTs ranges from a palm-sized 1-inch tube to a full 14 inches and more. We can

also design a CRT to your particular application.

All this together makes a powerful statement.

And it explains why so many builders of high-performance systems carry the torch for Litton CRTs.

If you have an application where resolution, cleanliness, throughput and uniformity of color are critical, contact Litton Electron Devices, 1215 South 52nd St., Tempe, AZ 85281. (602) 968-4471. TWX: 910-950-0149.



## **Litton**

## Electron Devices

# Row-to-column impedance of an $N \times M$ matrix circuit

BY HOWARD C. NEDDERMAN

**M**ATRIX circuits are involved in various kinds of devices such as displays and imagers. For testing as well as other purposes, an expression giving the expected row-to-column ac impedance variation over the face of the matrix would be useful, and such is developed here.

The matrix circuit to be discussed is shown in Fig. 1. In the figure,  $Z_c$  and  $Z_r$  are arbitrary lumped impedances. The row lines are assumed to be perfect conductors.

It is desired to obtain an expression for the impedance  $Z_{q,p}$  between any row terminal  $q$  and any column terminal  $p$  with all other lines open. Because the individual rows are equipotentials, it is possible to coalesce the circuit of Fig. 1 to that of Fig. 2, as the impedance has no dependence on column selection.

Rearrangement results in the array of Fig. 3 in which the entire  $N \times M$  matrix is shown schematically. In the figure, the loop currents and their direction due to an applied voltage  $V$  are indicated. Note that any external impedance in column  $p$  is omitted.

As in conventional lumped transmission line theory, the approach is to set up the appropriate loop current difference equations and to solve these consistent with boundary conditions. The mathematics is more complicated in this application because one of the input terminals can be

anywhere along the line, not just at the beginning.

## Loop equations

With reference to Fig. 3, the loop equations are:

$$I_{k-1} - AI_k + I_{k+1} = BI_1 \quad (1)$$

where  $k=2,3,4, \dots, q-1$ .

$$I_{q-1} - AI_q + I_{q+1} = \frac{(1-A)}{M} I_1 \quad (2)$$

$$I_q - AI_{q+1} + I_{q+2} = \frac{1}{M} I_1 \quad (3)$$

$$I_{k-1} - AI_k + I_{k+1} = 0 \quad (4)$$

where  $k=q+2, q+3, \dots, N$  with  $I_{N+1}=0$ .

In these equations the constants  $A$  and  $B$  are given by:

$$A = \frac{Z_r}{Z_c} + 2, \quad B = -\frac{1}{M} \frac{Z_r}{Z_c}$$

One other equation containing the applied voltage is needed. Tracing the left-hand path and the right-hand path of Fig. 3 between  $p$  and  $q$  gives, respectively:

$$\left( \sum_{k=2}^{k=q} I_k \right) Z_r + (I_q - I_{q+1}) Z_c = V$$

$$(I_1 - I_2) \frac{MZ_c}{M-1} + (q-1)I_1 \frac{Z_r}{M-1}$$

$$- \left( \sum_{k=2}^{k=q} I_k \right) \frac{Z_r}{M-1}$$

$$- (I_q - I_{q+1} - I_1) \frac{Z_c}{M-1} = V.$$

The summations can be eliminated to yield:

$$\left[ \left( \frac{M+1}{M} \right) Z_c + \left( \frac{q-1}{M} \right) Z_r \right] I_1 - Z_c I_2 = V. \quad (5)$$

Equations (1)-(4) are used to determine  $I_2$  in terms of  $I_1$ . Substitution in Eq. (5) then gives the impedance.

## Solutions

It is readily verified that set (1) has the general solution

$$I_k = Re^{+k\Gamma} + Se^{-k\Gamma} + \frac{1}{M} I_1$$

under the condition

$$e^{+\Gamma} + e^{-\Gamma} = A = 2 \cosh \Gamma. \quad (6)$$

$R$  and  $S$  are determined from the boundary conditions:

$$I_1 - AI_2 + I_3 = BI_1$$

$$I_{q-2} - AI_{q-1} + I_q = BI_1.$$

These result in

$$I_k = \left( \frac{\sinh(k-1)\Gamma}{\sinh(q-1)\Gamma} \right) I_q - \left( \frac{\sinh(k-1)\Gamma}{M \sinh(q-1)\Gamma} \right) + \frac{(M-1)\sinh(k-q)\Gamma}{M \sinh(q-1)\Gamma} - \frac{\sinh(q-1)\Gamma}{M \sinh(q-1)\Gamma} \Big) I_1 \quad (7)$$

where  $k=2, 3, 4, \dots, q-1$ .

The solution for set (4) is similar less the constant:

$$I_k = Pe^{+k\Gamma} + Qe^{-k\Gamma}.$$

Again,  $\Gamma$  must satisfy Eq. (6).

Howard C. Nedderman, prior to his retirement last year, worked in the field of TFEL at Kollsman Instrument Company, Merrimack, New Hampshire, a division of Sun Chemical.

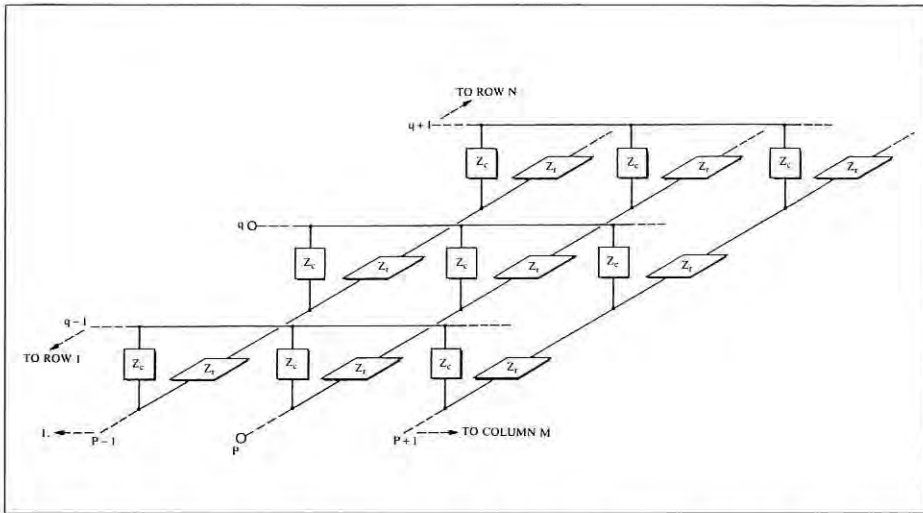

Fig. 1:  $N \times M$  matrix circuit.  $Z_c$  and  $Z_r$  are arbitrary lumped coupling and line impedances, respectively. Row lines are "perfect" conductors.

In this case the boundary conditions are

$$I_{N-1} - AI_N = 0$$

$$I_{q+1} - AI_{q+2} + I_{q+3} = 0.$$

These yield the relation:

$$I_k = \left( \frac{\sinh(N-k+1)\Gamma}{\sinh(N-q)\Gamma} \right) I_{q+1} \quad (8)$$

where  $k = q+2, q+3, q+4, \dots, N$ .

Equations (2), (3), (7), and (8) provide four relationships among the variables  $I_{q-1}, I_q, I_{q+1}$ , and  $I_{q+2}$  allowing them to be expressed in terms of  $I_1$ . Substituting appropriately in Eqs. (7) and (8) allows any  $I_k$  to be determined as a function of  $I_1$ . In particular,  $I_2$  can be found, and

this through Eq. (5) gives the impedance as

$$Z_{q,p} = \left( \frac{q-1}{M} \right) Z_r + \left( 1 - \frac{(M-1)\sinh(N-1)\Gamma}{M\sinh N\Gamma} \right) Z_c \quad (9)$$

where  $q = 1, 2, 3, \dots, N$ .

### Application to electroluminescent displays

Results are given for an  $N$  row by  $M$  column display with  $Z_c = 1/j\omega C$  and  $Z_r = R$  where  $C$  is the ordinary pixel capacitance

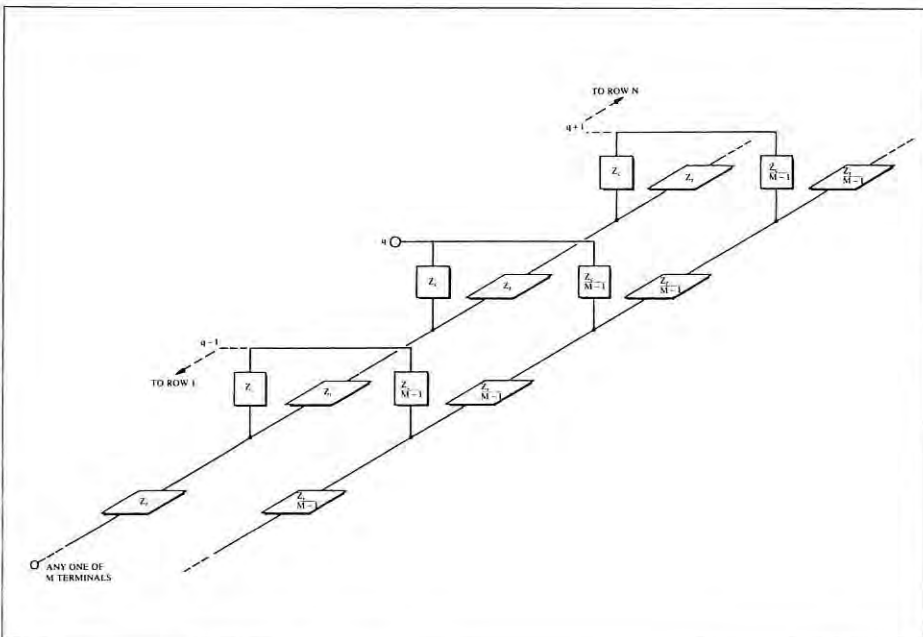

Fig. 2: Coalesced  $N \times M$  matrix circuit.

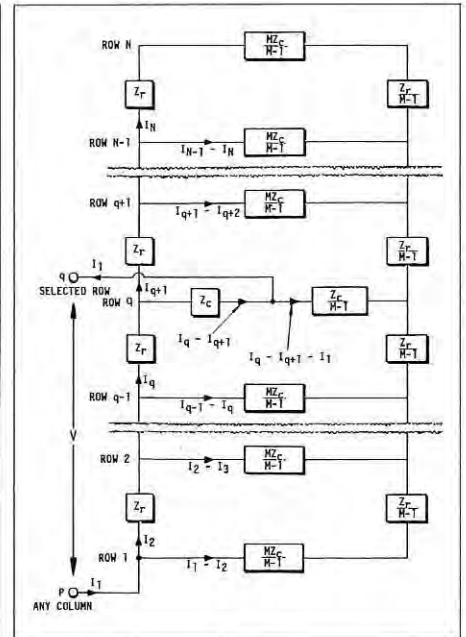

Fig. 3: Simplified  $N \times M$  matrix.

and  $R$  is the column resistance between pixel midpoints. It should be noted that these assignments are not quite accurate because the distributed nature of the column resistance influences the "lumping." However, the correction becomes important only when  $\omega RC$  is of the order of unity or greater, and this is several orders of magnitude beyond the range of any practical matrix display.

Typically,  $\omega RC$  is around  $10^{-6}$ . Expanding  $\cosh \Gamma$  in Eq. (6) gives  $\Gamma^2 \approx j\omega RC$ . Using this and expanding the hyperbolic term in Eq. (9) to terms of the first order in  $\omega RC$  gives the approximation

$$Z_{q,p} = \left( \frac{q-1}{M} + \frac{(M-1)(N-1)(2N-1)}{6MN} \right) R + \left( \frac{M+N-1}{MN} \right) \frac{1}{j\omega C} \quad (10)$$

Because normally  $M, N \gg 1$ , Eq. (10) can be further simplified to give

$$Z_{q,p} = \left( \frac{q-1}{M} + \frac{N}{3} \right) R + \left( \frac{M+N-1}{MN} \right) \frac{1}{j\omega C} \quad (11)$$

The reactive term in Eq. (10) or (11) is the familiar one easily obtained by altogether ignoring the resistance. The resistive term, apart from the unusual case of very small  $M$  and  $N$ , is seen to be quite insensitive to row selection and closely equal to  $NR/3$ . ■

# Company profile: Thin Film Device

## *finding a niche in the display business*

BY TED LUCAS

**F**OR A NEW company to survive in the electro-optical device business, it must find a profitable niche for product development—and do so rather quickly. Thin Film Device, Inc. (TFD), Anaheim, California, a manufacturer of custom optical coatings and products, lost no time in finding its place. According to Saleem Shaikh, the company's young founder and president, TFD has doubled its volume each year since its start in July, 1984. Hard work and the hiring of eager graduate students have also contributed to the success of this small but rapidly growing high-tech firm.

As the company name suggests, TFD concentrates on active devices consisting of thin films. Deposition of a wide variety of metals, dielectrics, phosphors, solar absorbers, and transparent conductors on many different substrates has produced most of TFD's business, along with a continuing R&D effort to develop and improve thin-film electroluminescent (TFEL) displays in yellow and other colors. TFD is now making EL panels with a dark-background matrix in sizes up to 4 x 6 in. According to Mr. Shaikh, "The dark-background material formula we have developed is proprietary and represents an advance in the state of the art."

### **Pathway of an entrepreneur**

Born in Karachi, Pakistan, the founder of TFD was graduated with a B.Sc. from the university there and came to the United States in 1971 as an engineer for Hycom,

Inc., a subsidiary of Sharp, Irvine, California. He worked on semiconductor properties and devices, making analyses of many materials and developing advanced fabricating techniques for metals, semiconductors, phosphors, and ceramics. Mr. Shaikh also worked extensively with TFEL materials and displays. During this time he earned an M.S. degree in materials science from the University of Southern California and became a member of the SID Los Angeles Chapter.

When Mr. Shaikh founded TFD as a small, high-tech enterprise, he surrounded himself with exceptionally intelligent employees: carefully recruited graduate students from nearby universities. These bright young assistants also helped him to build a large class-100 clean room within a modern industrial structure not far from California State University, Fullerton, and such major firms as Hughes Aircraft Company, Interstate Electronics, Northrop, and Rockwell International [Fig. 1].

### **Production techniques**

At present, TFD's production equipment includes two magnetron rf-dc sputtering units; three large E-beam vacuum deposition systems; one chemical vapor deposition (CVD) in-line coater; and a complete photolithography system consisting of a precision submicron exposure unit, spinner, spray coater, and automated etcher. Test equipment includes a Dek/Tek automatic capacitance/voltage (CV) and current/voltage (IV) tester; ellipsometer, electrometer, several binocular microscopes and oscilloscopes, and a metallograph for precision measurements of the coating thickness.

Three principal methods of vacuum deposition are used at TFD. Magnetron sputtering techniques are selected to achieve high deposition rates, small grain size, and dense coatings when creating thin films of metals, alloys, dielectrics, and phosphors with repeatable results. Electron beam and thermal evaporation methods are the other two technologies used to produce thin films with modified structures, mixing ratios, and variable grain sizes. A plasma-enhanced chemical vapor deposition (CVD) process produces superior conformal dielectric films for passivation and insulation of semiconductor devices. Having all these capabilities, even though on a small scale, allows TFD to service and explore a wide variety of material applications and to scout for new products.

Products produced at TFD in substantial quantities include multilayer metalized thin films with molybdenum, chromium, nickel, gold, germanium, and other metals in a variety of combinations for such applications as hybrid circuits on ceramic substrates, hermetic seal bonds for fiber-optic displays and sensors, and electrical contacts for infrared and frequency sensors and for quartz crystals. Nichrome (tantalum nitride with either nickel or titanium-tungsten and gold overplate) is used to make both active and passive hybrid devices with line geometries less than 1.0 mil for rf applications, including microwave components. Standards for applications such as ophthalmologic surgery (radial keratotomy) and automatic laser inspection for hybrids are produced routinely.

For optical and microscopy applications, TFD produces custom chrome

---

*Ted Lucas is a contributing editor to Information Display.*

blanks, reticles, gauge blocks, comparators, and CRT face projectors. In making chrome masks for flat-panel displays and semiconductor applications, TFD's president says his methods can assure that the accuracy and definition of alignment lines are maintained within less than  $2\ \mu\text{m}$  at low cost [Fig. 2].

Conventional transparent conductors provided include indium tin oxide and antimony-doped tin oxide. TFD has developed a low-temperature process for applying zinc oxide doped with aluminum or indium to flat-panel displays, memories, conductors, photovoltaic panels, and electromagnetic interference (EMI) shields. As an example, this low-temperature process is useful in applying a conductive coating over solar cell panels or multilayer TFEL structures, whereas higher temperatures would damage films already deposited. Another proprietary transparent conductor based on indium tin oxide has been developed. It has superior electro-optical characteristics. Resistivities of as low as  $5\ \Omega/\square$  of material are obtainable at  $1400\ \text{\AA}$  with 89% transmission. Reliability and environmental tests are under way.

Deposition of a variety of phosphors, including CdS, TbS, ZnSe, PbTe, ZnS, CdTe, GdOS, P-20, and other compositions has led to such applications as TFEL displays (both orange and green), lamps for backlighting LCDs, CRT screens, light valves, cockpit and instrument panel indicators and displays, fiber-optic devices, piezoelectric photoconductors, and detectors.

TFD's expertise with deposition techniques often attracts customers with special problems. An aerospace research facility recently approached TFD for help



Fig. 1: Inspecting TFEL lamps under a binocular microscope in the clean room.

in providing coatings on graphite fibers to produce a composite fiber with improved qualities. "Our contribution was a barrier coating and a metallic overcoat for continuous filament," says Mr. Shaikh, "so that the final fiber could be easily bound into its final composite metal base material. This resulted in an eventual composite material both stronger and lighter than any of the materials from which it was derived."

Typical dielectrics applied by TFD include silicon dioxide and nitride, aluminum dioxide, yttria, and other composites used as passivation or isolation layers, or to make thin-film capacitors. Solar absorbers such as carbides and silicides have been deposited to produce resistive elements, photovoltaic cells, light-absorbing films, high-temperature solar coatings, and special displays.

Custom transparent indium-tin-oxide electrodes, high-brightness TFEL yellow and green lamps, hybrids, and discrete resistors are high-volume products. "Custom coatings and products represent most of our business, although specialties and new products are increasingly in demand," says Mr. Shaikh. Among TFD's customers for such products are Allegheny International, Monolithic Memories, Myocure, Poly Research, Westinghouse, Ametek, Hughes Aircraft Company, Litton, Rand, Scriptel, SAIC, and numerous avionic and medical product manufacturers.

### New developments

"Development contracts with TFD customers have made it possible," Mr. Shaikh says, "to evolve composite dielectrics for flat-panel displays, phosphors for light valves, high-contrast films for night-vision panels, nonconductive films to absorb ambient light, and low-stress transparent optical coatings."

A major contributing R&D effort by TFD is the development of improved TFEL lamps and displays. "Our TFEL green lamps have achieved longer and more reliable life than powder EL lamps," Mr. Shaikh declares. "Our lamps also deliver greater light intensity. We are now providing, in limited quantities to some of our major customers, dot-matrix TFEL displays in both yellow-orange ( $5850\ \text{\AA}$ ) and green. High-contrast films created at TFD have shown a 2:1 contrast ratio under ambient sunlight conditions of up to 7000 fC. Our major display users have commented on TFD's new TFEL unit as markedly superior in appearance



Fig. 2: Loading chrome blanks prior to vacuum deposition.

and reliability as compared with conventional circularly polarized EL displays. Also, the TFD display has lower power consumption."

Another new development that has Saleem Shaikh and his associates excited is a photochromic rearview mirror for automotive use. A motorist using this new device will not have to change the position of the rearview mirror if there are glaring headlights behind the car. Patent applications are pending. After further development, TFD will furnish samples of this new mirror to leading automotive manufacturers.

"This photochromic coating material has many other possible applications," Mr. Shaikh says. "It can be used for visible and IR shutters, screening for lasers, and as an architectural material for windows. We intend to offer our process to large firms on a royalty basis, since TFD is primarily a high-tech research company with no present intentions to get into mass production of consumer products."

Although most startups in the electronics industry can expect to lose money or at best break even during their first three years, TFD has consistently earned good profits. TFD's growth can be attributed to an insistence on quality control, the development of improved process techniques, and the ability to create new products meeting the needs of advanced display technology. Other factors in the company's success are Mr. Shaikh's willingness to work 14-hour days for weeks on end when required; his selection of highly competent assistants, many of them graduate students earning and learning; and his good business judgment, instilled by his Pakistani family and American educators and employers. ■

# Sharing information with the public via IPIS

BY IFAY F. CHANG

**I**NFORMATION regarded as a commodity could be made available through information services in the coming decade. How this information service industry emerges depends very much on the development of an intelligent public information system (IPIS). In Singapore, we have launched a nationally supported research program at the Institute of Systems Science (ISS) to develop an IPIS that can provide an intelligent means of sharing information and eliminate the tremendous duplication in data creation and maintenance, software development and maintenance, and information applications that now exists. The Telecommunications Authority of Singapore (Telecoms) is a partner in this research effort.

There are other public information systems along the lines of videotex being developed elsewhere; however, IPIS stresses the word intelligent because a great deal of intelligence must be incorporated in the hardware and software of the information system to facilitate the transmission, communication, processing, and presentation of information. The system must be capable of offering information and intelligent software tools in a friendly and easy-to-use manner for information processing and handling. This sharing of information in an intelligent way is the basic concept for making IPIS economically feasible.

IPIS is envisioned as a common source of information (infoware) that can be shared by its subscribers. The usual overhead of maintaining information or

data bases by its subscribers will be saved. This infoware will be a commodity, and the advantage of the old computer-time-sharing system will be brought back, with added capability in terms of wide-band communication, high intelligence information, and workstations.

The basic concept of IPIS is to take advantage of available hardware technologies such as wide-band communication, large-capacity storage, advanced I/O devices, and powerful computers to build a system allowing a variety of information services with multilingual (programming language and limited natural language), multimedia (text, graphics, and image), and intelligence capabilities.

## IPIS at ISS

Our research at ISS is directed toward the development of software tools and techniques to support an intelligent workstation that has multimedia, multilingual, and intelligent interfaces, both in terms of hardware and software.

Because Telecoms is currently evaluating and developing an enhanced videotex system (the Teleview program, based on TV broadcast and PSTN), we plan to use our partner's broadcast channel as the primary transmission medium when testing our IPIS results [Fig. 1]. Nevertheless, a fiber-optic or any other wide-band cable could be used as the primary communication medium.

To develop an IPIS we have initiated seven research projects supported by four research disciplinary areas at ISS:

- office automation and local-area networks.

- multilingual computers and workstations.
- optical disk storage and data-base management.
- knowledge base systems (AI and expert).

This program encompasses only the first of three long-term R&D phases, to be followed by the creation, preparation, and handling of infoware, concluding with the distribution and networking of IPIS.

## IPIS prototype project

Development of an IPIS prototype requires strong interaction among our research groups, with several projects involving multidisciplinary areas. The prototype project group coordinates activities of the various project groups, and also monitors the availability of commercial products, research advances, and any emerging standards affecting IPIS-like services. When a prototype workstation has been defined and constructed, this group will perform an integration test with all the software developed by the other project groups.

## Optical disk data-base project

For any data-base system, one needs to choose a data model to work with. Several data models were studied, but none was found suitable for a multimedia data-base system. Thus, an independently developed data model, CHERA (class hierarchal entity relationship attribute data model) was adopted for this project. CHERA is an object-oriented data model.<sup>1</sup>

---

Ifay F. Chang is director of research, Institute of Systems Science, National University of Singapore.



The next step was to decide on a logical data structure that would be useful for data entry and editing. The "frame" concept from AI was borrowed and this concept has been enhanced by defining four individual quadrants to hold specific information. The first quadrant will hold the information regarding an object; the second, information on the relationship of this object with other objects; the third, information on the operations permitted on this object; and the last, special information about this object such as the image and access information.<sup>2</sup>

### Chinese languages project

The rationale for this project is to provide an intelligent and friendly Chinese input scheme for information retrieval by casual users. After making studies in cognitive psychology, linguistics, and computing science, we adopted a design approach of WYSIWYG (what you see is what you get), based on rules of chunking, rules of association, and statistical linguistics so that no learning is required to use this input method.

With the help of many students from the National University of Singapore as well as overseas universities, a prototype was built on an IBM PC/AT with EGA adapter and Microsoft mouse for demonstration. Feedback received is very encouraging. A very specific input method is now being developed for Telecoms to adopt in its Teleview program as a second Chinese input scheme, complimentary to the Hanyu Pinyin method. The next phase of our project will be done on a Xerox 1186 AI workstation with its high-resolution display, large amount of RAM, and good software development environment.

### Intelligent user interface project

Because the main users of IPIS will be members of the general public, the main thrust of the design is to achieve ease of use and high usability. The system should be able to:

- anticipate user intentions;
- provide meaningful and cooperative responses; and
- facilitate a multimodal form of user-system interaction.

Anticipation of user intentions means the ability of the system to map users' goals to the system's representation of those goals. This is achieved through the development of task profiles to model possible task scenarios in a given domain. A task profile describes the component subtasks which make up a task scenario and the relationships between these components.

To provide meaningful responses to users, it is important for the system to have knowledge about its users and their needs and requirements. This knowledge is represented in the system as static and dynamic user profiles. Static user profiles encapsulate stereotypical knowledge about particular user groups. Dynamic user profiles encapsulate knowledge about the current user and are generated at runtime during the system's interaction with the user. Both the static and dynamic user profiles are used by the system to tailor responses to users according to individual task needs and preference.

To further enhance the system's usability, we are investigating ways of providing cooperative responses to users to give sug-

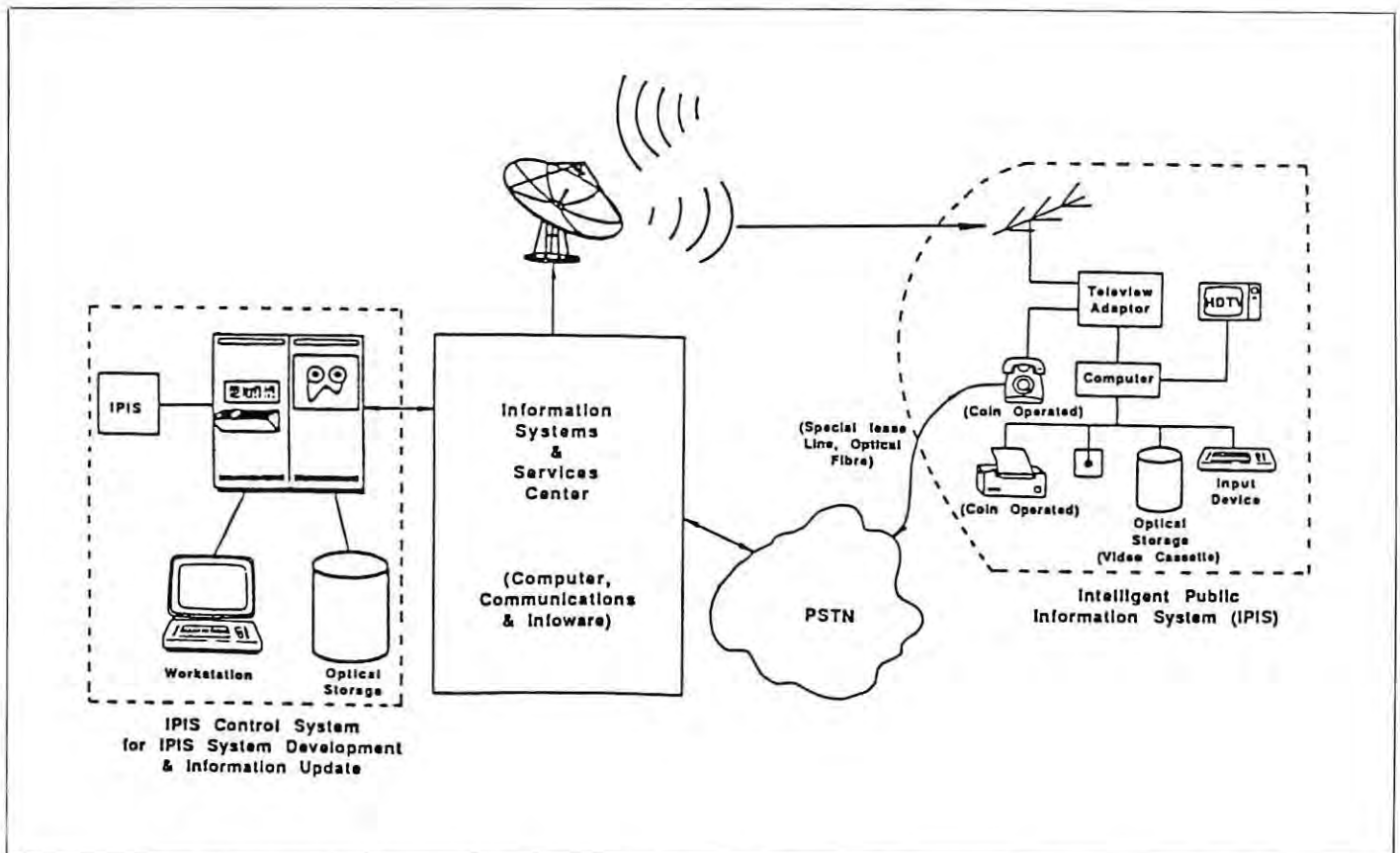

Fig. 1: Schematic of the IPIS in which the TV broadcast channel is used as the primary transmission medium. Optical fiber or other wide-band cables could be used instead.

gestions and recommendations whenever necessary, as well as provide alternative answers when the required information is not available in the data base. To do this, the system must possess meta-level knowledge about the data base and the users. We plan to implement this using a rule-based inference mechanism.

We are currently implementing our prototype using Smalltalk/V on the IBM PC/AT, which offers a good environment for fast prototyping work. The visual display of our user interface has been designed to accommodate multimodal interaction. Information is presented in the form of text, graphics, and digitized images. The user interacts with the system through icons, menus, and list selections. We have tried to eliminate some of the major problems associated with other menu-based information systems in our current design. We are also currently developing the task profiles and user profiles which we hope to implement in our first-stage prototype to be completed in 1987.

### Data compression project

The objective of this project is to design and develop a full-color picture processing system for IPIS that incorporates image data compression algorithms to facilitate efficient information transmission and storage. The data structures of digital color images are generally huge; for example, a frame of 640 × 512 resolution full-color image consists of close to a megabyte of data. To provide such information to the users in IPIS, a compression method on the order of 10:1 compression ratio is desired for maintaining good response time and efficient memory usage.

A brief study of all popular image compression algorithms was performed, and vector quantization was found to be the best algorithm because of its high (8:1) compression ratio and easy-to-implement (low-cost) decoder. It is a very suitable algorithm for single-encoder and multi-decoder applications, as the proposed IPIS work was started on low-rate image compression using vector quantization.

We designed and simulated a new method of vector quantization, the predictive classified vector quantizer (PCVQ), using the IBM 3081. The PCVQ exploits spatial correlations across the boundaries of the pixel blocks to achieve higher compression rate. Edge (high-contrast area of the image) and mean intensity information of each block can be predicted and classified. The determined class allows the

block to be coded by a quantizer belonging to the same class. The PCVQ consists of a compact and optimized subcodebook and gives satisfactory performance at a 20:1 compression ratio.

We have integrated a simple image processing system for this project that includes a color video camera, color video signal digitizers, RGB monitor display, and an IBM PC/AT as the host computer. This system gives us a convenient way to digitize and edit color images. We also pass the captured image data to a IBM 3081 main frame for computational intensive processing.

Research on the design and fabrication of a picture information system for the IPIS continues. We would like to devise a fast and convenient way of generating and editing pictures to speed up operations in such an information system. We are also looking into the utilization of a broadband network for high-speed information transmission. To complete the system, we would like to build an image data base that includes efficient storage (compressed or analyzed image) and retrieval (query and browse) methods.

### Graphics package project

Because tremendous information can be conveyed through motion, a complex animation sequence will be an integral part of the IPIS. The objectives are to:

- *develop an easy-to-use interactive graphical environment* for the user to create, edit, retrieve, store, and display animation sequences.
- *develop a compact object-oriented animation language* for representing graphical objects and motion dynamics in animation.
- *develop a visual language* for the graphical specification and control of complex animation sequences.
- *provide facilities for the user to simulate* the effect of different videotex protocols, display resolution, and drawing speeds.

This project also aims to provide all the facilities necessary to produce high-quality graphic images, including animation for the IPIS.

### Expert systems and natural language project

ISS's interest in the expert system technology came naturally, as we are aware of the power of the expert system and machine intelligence in general. Furthermore, we regard knowledge-base and expert systems as important parts of the

infoware to be offered as information services within the concept of IPIS.

The project has started with some well-defined application domains. The interesting general domain of tourist information is the focus of the prototype implementation. Two information/knowledge subdomains—local food knowledge and restaurant information and the historical information of Singapore—were chosen and studied. These domains posed great challenges but proved to be excellent ones for prototyping. The first prototype of this system is targeted to be ready for demonstration in September, 1987. The group is confident of incorporating into the system new techniques of reasoning, knowledge representation, object classification, knowledge-base and data-base interface, generalization and knowledge-base primitives, path-finding, textual and graphical presentation of information, and query language.

### References

- <sup>1</sup>A short description of this data model can be found in "CHERA: A Class Hierarchical Entity Relationship Attribute Data Model," a paper submitted for presentation at the 13th International Conference on Very Large Data Bases in England in September 1987.
- <sup>2</sup>Some of the design details of the system are described in the paper, "Methodologies and Applications of Visual Languages for Information Services," to be presented at the IEEE Computer Society 1987 Workshop on Visual Languages in Sweden in August 1987. ■

This article has been adapted from Dr. Chang's keynote address at the South East Asia Regional Computer Conference and Exhibition (SEARCC '86) held in Bangkok, Thailand, November 17-21, 1986, and ISS's 1986 *Annual Report*.

**Starting soon**

## ID Classified

- job opportunities
- positions wanted
- consultants
- business opportunities

# You had to have been there. . .

BY THE EDITORIAL STAFF

**N**O ONE who attended the annual SID luncheon on Wednesday, May 11, will ever again look at a roll of astronomical distance paper—as demonstrated by George Reed and several volunteers from the audience—in quite the same way again. But to try to explain—well, you had to have been there.

One can gain an impression of the scope and depth of SID '87 by reading the *Seminar Lecture Notes* and *Symposium Digest* (or even by skimming the abstracts in the advance program sent to all *ID* subscribers). But the speakers did deviate from their advance texts: they amplified, modified, explained. They used a variety of visual aids—after all, our field is information display—and any dedicated photographer trying to capture it on film had to be there to snap the shutter. Most important, each talk was followed by a question-and-answer period, during which anyone could query or challenge the speaker. And of course there could be no preprinted notes for the Symposium author interviews, held at the end of each afternoon's sessions. Whether examining a prototype (sometimes in groups resembling a feeding frenzy) or asking the speaker for additional information or clarification, all had the chance to see or speak about what had been described.

Sixty-seven exhibitors set up their booths in the French Market Hall at the Hyatt Regency (and someone suggested that the logistics entailed in organizing the chaos while trying to set up the exhibits might make an interesting *ID* article). We could list all 67 companies, but there is a large difference between reading a list and

seeing the exhibitors and their products. Again, there is nothing like face-to-face interactions and the opportunity for demonstrations and questions and answers, not to mention picking up brochures, spec sheets, and assorted freebies or of having someone use your camera to take a picture of you standing by one of the GM concept cars.

In sum, there was something for everyone at SID '87. Some talks had such broad appeal that it was standing room only; other, more esoteric subjects attracted only experts in the field. No one could attend every session (nor would a sane person attempt such an information overload in such a short time), but all could pick and choose as desired. All could engage in informal, unstructured

discussions with colleagues, whether in the exhibit hall, at the various social events (such as on the riverboat or over a piece of SID's 25th anniversary cake), during breaks in the sessions, at meals, or simply in passing.

For the partial edification of our 9000-odd readers who were not at SID '87, the *Symposium Digest* and *Seminar Lecture Notes* are available from SID, 8055 West Manchester Avenue, Suite 615, Playa del Rey, CA 90293, at \$55 for the *Digest* (\$45 for SID members) and \$50 for the two-volume set of *Seminar Notes* (\$35 for members). These are only poor substitutes for having been there, though. Start planning now to attend SID '88, to be held May 23-27 at the Disneyland Hotel in Anaheim, California. ■



Dr. and Mrs. Harold Luxenberg and Dr. John van Raalte (right) cut SID's birthday cake.

Compiled by HOWARD L. FUNK  
IBM CORP.

*U.S. Pat. No. 4,663,670; Issued 5/5/87*  
**Television Receiver Having a Liquid Crystal Display Device**

*Inventors: NOBUYUKI HASHIMOTO, KATSU ITO, AKIRA MIYAJIMA, SHIGERU MOROKAWA, MINORU NATORI, HIDESHI OHNO, MUNEHIRO SHINABE, AKIRA TSUZUKI*

*Assigned to: CITIZEN WATCH CO., LTD.*

A television receiver having a liquid crystal display device includes a receiver having an electromagnetically shielded case and a receiving circuit provided in the shielded case and electrically connected to an antenna for producing audio signals and video signals. A liquid crystal display panel of the liquid crystal display device is electromagnetically shielded by a transparent and conductive shielding film for shielding the liquid crystal display panel.

*U.S. Pat. No. 4,663,618; Issued 5/5/87*  
**Arbitrary Raster Blanking Circuit**

*Inventors: DONALD G. HAYLES, MARK N. HEPWORTH*

*Assigned to: ROCKWELL INTERNATIONAL CORP.*

An apparatus is disclosed for displaying arbitrary forms on a raster-scanned cathode ray tube converting the analog X and Y deflection voltages of the raster signal directly into a digital TTL level blanking signal. The circuit designer, utilizing Cartesian or polar coordinates, specifies a desired shape and its location utilizing the appropriate formulas. In this manner, a number of raster cut-out circuits are readily coupled to define a desired number of arbitrary shapes on a raster-scanned cathode ray tube.

*U.S. Pat. No. 4,663,562; Issued 5/5/87*  
**Contrast Enhancement Structure for Color Cathode Ray Tube**

*Inventors: SUSAN B. JAFFE, GARY MILLER*

*Assigned to: GENERAL ELECTRIC CO.*

A contrast-enhancement structure for a full-color cathode ray tube utilizes a combination

of a louvered ambient light transmission control element in combination with a multi-notch band-pass filter. The louvered control elements provide limited viewing angles for incoming ambient light reducing light dispersion on the cathode ray phosphor surface. The multi-notch band-pass filter provides efficient spectral transmission in the phosphor emitting wavelengths. The combination of the louvered directional control elements for ambient light and a multi-notch band-pass filter matching the spectral emission characteristics of the color phosphor substantially increases the contrast ratio. In fact, this arrangement provides contrast ratios which are of an order of magnitude larger than those previously possible.

*U.S. Pat. No. 4,662,719; Issued 5/5/87*  
**Liquid Crystal Display and Method for Production**

*Inventors: DONELLI J. DI MARIA, HANS P. WOLF*

*Assigned to: IBM CORP.*

A matrix addressable liquid crystal display includes a thin-film circuit supported on a substrate having a plurality of parallel bit lines. A plurality of individual pixel circuits each include a two-terminal bi-directional gate device which is formed from at least one thin-film layer with one gate device terminal connected with the associated bit line. A terminal plate is connected in circuit with the other terminal of the gate device. A transparent cover plate is spaced above the thin-film circuit with a transparent conductor structure on the underside of the cover plate. The space beneath the cover plate is filled with a liquid crystal display material to form individual display pixel circuits at the terminal plates. A plurality of parallel word lines are arranged orthogonally to, and insulated from, the bit lines. The word lines are connected in circuit with the individual display pixel circuits at the respective cross-overs with the bit lines. The pixel circuits are each operable to change the state of the associated portion of the liquid crystal display material in response to the concurrent application of voltage pulses of opposite polarities to the associated word and bit lines.

*U.S. Pat. No. 4,661,812; Issued 4/28/87*  
**Data Transfer System for Display**

*Inventor: YOSHIKI IKEDA*  
*Assigned to: FANUC, LTD.*

In a display, unit data for rewriting a picture memory is prepared in a work memory and the data is transferred to the picture memory utilizing the vertical blanking period of the picture being displayed on the screen. When the

amount of data to be transferred is large, the data transfer is continued in excess of the vertical blanking period and during the data transfer the display on the screen is inhibited.

*U.S. Pat. No. 4,660,935; Issued 4/28/87*  
**Liquid Crystal Display Device Having Electrodes Shaped to Compensate for Positioning Error**

*Inventors: YUKIHIRO IWASHITA, KOTARO UENO*  
*Assigned to: SEIKO EPSON CORP.*

A matrix-type liquid crystal display device for use in alphanumeric and television displays and the like has a screen in which division of images produced by the display screen resulting from assembly error is eliminated by means of reduction in the areas of the picture-forming elements near the region where end portions of the signal electrodes project between control electrodes.

*U.S. Pat. No. 4,660,098; Issued 4/21/87*  
**Apparatus for Producing Copies of a Video Image Utilizing Line Pattern Rotation**

*Inventor: DANA W. WOLCOTT*  
*Assigned to: EASTMAN KODAK CO.*

An apparatus is disclosed for producing "hard" color copies of a video image utilizing line pattern rotation to reduce the visual perception of "raster" lines and improve image quality. Line pattern rotation is accomplished by rotating the raster line pattern of a CRT relative to the displayed image between each exposure of the color components of the composite video image.

*U.S. Pat. No. 4,659,968; Issued 4/21/87*  
**Vertical Deflection Circuit**

*Inventor: AKI NAKAMURA*  
*Assigned to: MITSUBISHI DENKI*

Circuitry is disclosed for automatically vertically centering a video display on the face of a CRT when deviations result from different raster scanning items. A comparator having inputs flanking a resistor, connected in series with the vertical deflection coil, detects the zero or picture plane center crossing points of the deflection signal. The zero crossing points are then time compared with a pulse signal whose width represents the overall time duration of each raster scan for the picture or image being displayed, and a dc correction component is applied as necessary to the deflection signal such that the adjusted zero crossing points bisect the duration pulses to thus vertically center the display.

*Used with permission of IFI/Plenum Data Co.*

*U.S. Pat. No. 4,660,030; Issued 4/21/87*

**Liquid Crystal Video Display Device**

*Inventor: SHUJI MAEZAWA*

*Assigned to: SEIKO EPSON CORP.*

This invention is directed to an improved liquid crystal video display device. An interlacing video display technique is utilized and scanning signals are provided to every other scanning electrode line in sequential order, shifting selected lines every frame. An additional selected voltage is provided during the time period which overlaps the selected scanning electrode lines to the adjacent non-selected electrodes both above and below the selected scanning electrode lines. A high-resolution display is provided while reducing associated flicker by driving all scanning lines in the desired order.

*U.S. Pat. No. 4,659,181; Issued 4/21/87*

**Liquid Crystal Displays and Method by which Improved Apparent Viewing Cones Are Attained Therefor**

*Inventors: ROBERT G. MANKEDICK,*

*SYED NASEEM*

*Assigned to: NCR CORP.*

Liquid crystal displays having improved apparent viewing cones are disclosed. The displays are activated by an electrical energizing signal which comprises an activation signal portion and a superimposed ac voltage signal by which the apparent viewing cone angles of the displays are increased.

*U.S. Pat. No. 4,659,183; Issued 4/21/87*

**Backlighted Liquid Crystal Display**

*Inventor: OSAMU SUZAWA*

*Assigned to: SEIKO EPSON CORP.*

A liquid crystal display panel is disclosed that has a backlight for providing high brightness, uniformity of illumination intensity, small thickness, and high efficiency, and that can be manufactured at a low cost. The display device includes a liquid crystal display panel, a light source for illuminating the liquid crystal panel, and a light passage member, which can be formed of either transparent or translucent material disposed between the liquid crystal panel and the light source. The light source inlet side of the light passage member is formed with a recess so that the thickness is reduced at the region opposed to the brightest region of the light source. A light reflecting member substantially surrounds the light source, and the light passage member is formed with an opening facing the liquid crystal panel to expose a surface portion of the light passage member. The light source can either be an in-

candescent light bulb or a cold-cathode discharge tube. In the latter case, a thermistor is coupled in series with the tube to stabilize its temperature and hence stabilize the illumination intensity against changes in ambient temperature.

*U.S. Pat. No. 4,659,182; Issued 4/21/87*

**Multilayered Matrix Liquid Crystal Display Apparatus with Particular Color Filter Placement**

*Inventor: MASANOBU AIZAWA*

*Assigned to: STANLEY ELECTRIC CO. LTD.*

A multilayered liquid crystal display device includes a front substrate, a rear substrate, and at least one intermediate substrate interposed therebetween, respective spaces being formed between the intermediate substrate and the front substrate, and between the intermediate substrate and the rear substrate. Liquid crystal layers are in the spaces between the substrates so that the display surfaces provide an overall display. Intersecting signal and scanning electrodes are arranged on opposed mutually facing surfaces of the intermediate and rear substrate and of the intermediate and front substrate. Color layers are arranged in an optical path corresponding to the intersecting portions of the signal and scanning electrodes, but on the opposite side of the intermediate substrate on which the associated intersecting signal and scanning lines are located. The color layers are not interposed between their associated intersecting signal and scanning electrodes. The display is arranged in adjacent sections, each adjacent section being on opposite sides of the intermediate substrate, thereby producing a uniform display surface.

*U.S. Pat. No. 4,657,347; Issued 4/14/87*

**Liquid Crystal Display with Zener Diode**

*Inventor: YOSHIHARU NISHIMURA*

*Assigned to: TOKYO ELECTRIC CO., LTD.*

A liquid crystal display apparatus includes a liquid crystal display device having a plurality of display digits, a one-chip microcomputer having a plurality of voltage terminals for driving the liquid crystal display device by selectively supplying the voltages applied to those voltage terminals to the liquid crystal display device, and a power supply circuit for applying voltages to the voltage terminals, this power supply circuit having a series circuit of a plurality of resistors, one end of which is connected to the first power source terminal and which has a plurality of nodes connected to the

voltage terminals. The power supply circuit has a zener diode which is connected between the other end of the series circuit and the second power source terminal and which is made operative in the saturation region.

*U.S. Pat. No. 4,657,316; Issued 4/14/87*

**Viewing Screen with a Swiveling Screen Housing**

*Inventors: NORBERT BONKE,*

*WALTER HARDT, FRANZ*

*WERNER*

*Assigned to: NIXDORF COMPUTER A.G.*

The invention relates to a viewing screen unit with a viewing screen housing, supported swivelably around a swivel axis. The viewing screen housing has the shape of a circular cylinder segment, where the viewing screen plane essentially coincides with the intersecting plane of the circular cylinder segment and the pivot axis coincides with the cylinder axis. In a preferred embodiment, the viewing screen housing is fastened swivelably onto a receiving housing containing at least part of the components. The receiving housing is provided with a concave recess turned toward the viewing screen housing, which recess fits closely against the curved rear wall of the viewing screen housing. The supporting of the swivelable viewing screen housing is preferably done by supporting means which act on either the inside of the end faces or on the curved back side of the viewing screen housing.

*U.S. Pat. No. 4,658,288; Issued 4/14/87*

**Beam Index System with Switchable Memories**

*Inventors: RICHARD W. MIDLAND,*

*BORIS ROZANSKY*

*Assigned to: ZENITH ELECTRONICS CORP.*

A beam-index CRT system includes a pair of memories that are selectively operated to store lines of data from a source and to supply stored lines of data to a CRT. A plurality of NOR gates and flip-flops toggle memory addressing means and simultaneously apply appropriate timing signals thereto for controlling the memory writing and reading operations.

*U.S. Pat. No. 4,658,246; Issued 4/14/87*

**Matrix Display Simulation**

*Inventor: GILBERT G. KUPERMAN*

*Assigned to: SECRETARY OF THE U.S. AIRFORCE*

A system is disclosed for simulating the display of visual images by a matrix of liquid crystal



**LONDON**  
**15-17 SEPTEMBER 1987**

The 7th International  
DISPLAY RESEARCH CONFERENCE  
will be held at the Institution of Electrical Engineers,  
London WC2, from 15-17 September 1987.

The conference is sponsored by THE SOCIETY FOR INFORMATION  
DISPLAY and THE INSTITUTE OF PHYSICS, in collaboration with  
THE INSTITUTION OF ELECTRICAL ENGINEERS, N T G,  
CLUB VISU and THE HUMAN FACTORS SOCIETY.

The **Keynote Lecture** will be given by Professor C Hilsum, FRS  
(GEC Plc), and the topics of other Invited Lectures are  
**Implications of HDTV for displays, Flat CRTs,  
Prospects and problems of ferroelectric liquid crystal  
displays, Present and future progress in LC materials,  
Progress in active matrix addressing of LCDs,  
Human factors in display design and applications.**

*Further information and registration forms from:*

Mr Clive Jones, Meetings Officer, The Institute of Physics,  
47 Belgrave Square, London SW1X 8QX.

## patents

cells or other matrix elements and providing flexibility in selecting display characteristics such as element size, active area ratio, and signal noise content. The display preferably employs a cathode ray tube and uses software signal processing.

*U.S. Pat. No. 4,655,553; Issued 4/7/87*  
**High Contrast Backlit Liquid Crystal Display System**

*Inventor: HERMAN C. KLEIN*  
*Assigned to: McDONNELL DOUGLAS CORP.*

Use of a special blue or blue-green optical filter in a single or double layer dichroic liquid crystal display which is backlit by dimmable incandescent lights provides for easily read, high contrast presentation of information.

*U.S. Pat. No. 4,655,551; Issued 4/7/87*  
**Liquid Crystal Display with Chip Projecting Above and Below Flexible Film**

*Inventors: TAMAKI MASHIBA,  
MASUAKI MORINO, ISAMU  
WASHIZUKA*  
*Assigned to: SHARP CO.*

An arrangement of a liquid crystal display unit includes a display panel having a plurality of terminals, a plurality of flexible films made of electrically nonconductive material and a LSI chip bonded into each flexible film. A plurality of electrodes are deposited on each film, with the films being provided in association with the display panel to electrically connect each LSI chip with the display panel terminals.

*U.S. Pat. No. 4,654,717; Issued 3/31/87*  
**Cathode Ray Tube Arc-Over Protection for Digital Data in Television Display Apparatus**

*Inventor: JOHN W. STOUGHTON*  
*Assigned to: RCA CORP.*

Arc-over in the cathode ray tube of a digital television receiver produces a large current pulse which, when it discharges via the chassis ground, disrupts the reference ground potentials of other circuitry coupled to the chassis ground. The affected circuitry includes digital data storage elements which may experience random state changes caused by the fluctuating ground potential. The CRT arc-over condition is detected by circuitry which applies a pulse to the reset terminal of the microprocessor, causing it to restore the potentially corrupted data in the data storage elements using preset data stored in a less volatile programmable read only memory. ■

## have you read . . . ?

Compiled by HOWARD L. FUNK  
IBM CORP.

"High-Resolution Printing with Drop-on-Demand Ink-Jet Head," T. Ushioda, R. Uematsu, M. Takahashi, and H. Fukuchi, *NEC Research & Development*, No. 84 (1987), p. 14.

"A New and Improved CRT Imaging and Display Technology," D. V. Kloepffel and A. Malang, *SMPTE J*, Vol. 96, No. 1 (1987), p. 135.

"Novel Type of Emissive Flat-Panel Display: The Matrixed Cold-Cathode Microtip Fluorescent Display," G. Labrunie and R. Meyer, *Displays: Technology and Applications*, Vol. 8, No. 1 (1987), pp. 37-40.

"Chip Set Brings Bit Mapping to Low-End CRT Displays," C. Mackenna, J. Li, and J. Goodhart, *Electronic Design*, Vol. 35, No. 2 (1987), p. 88.

"Desk-Top Publishing: Faster and Cheaper," P. Smith, *Today's Office* (U.K.), No. 6 (February 5, 1987).

"Solving the Mysteries behind Display Resolution Capabilities of CRTs," *InfoWorld*, Vol. 9, No. 9 (March 2, 1987), p. 31.

"Four Ink-Jet Printers: A Look at Units Ranging from Black-and-White Portable to Full-Size Color," R. D. Swearingin, *Byte*, Vol. 12, No. 2 (February 1987), pp. 239-244.

"The Perfect Laptop," S. Alsop, *PC Magazine*, Vol. 6, No. 2, pp. 101-102.

"Large PC Monitors Easier on the Eyes," K. Milburn, *InfoWorld*, Vol. 9, No. 7 (February 16, 1987), pp. 40-41.

"LCD for Overhead Projectors Offers Clear Computer Images: Datashow Display System," A. Poor, *PC Week*, Vol. 4, No. 4 (January 27, 1987), pp. 59-61.

"Getting the Big Picture from Your PC's Little Screen," Michael Schrage, *Washington Post* (March 23, 1987), p. F21.

"In the Blink of an Eye," Gail Bronson, *Forbes* (March 23, 1987), p. 140.

"GE Roils the Interactive-CD Waters," Tobias Naegele and Jonah McCleod, *Electronics*, Vol. 60, No. 6 (March 19, 1987), p. 33.

"Amazingly Easy, Fast Graphics Program Displays 12 Formats," *InfoWorld*, Vol. 9, No. 11 (March 16, 1987), p. 46.

"Seiko Epson Taiwan Plant to Double LCD Output," *Japan Economic J* (March 14, 1987), p. 17.

"Thomson-CSF/GE/VDO Luftfahrt Collaboration on LCDs," *Interavia Air Letter*, No. 11, 206, p. 3.

"Two LCD Projection Panels Yield Alternative for Presentations," P. M. Chabal, *InfoWorld*, Vol. 9, No. 10 (March 9, 1987), p. 13.

"Moving Wafer Inspection into the Fast Lane," Jerry Lyman, *Electronics*, Vol. 60, No. 5 (March 5, 1987), p. 74.

"Uniting Silicon and Gallium Arsenide," John G. Posa, *High Technology* (March 1987), p. 38.

"Viewdata Gets the Picture Worth Watching," Geoffrey Charlish, *Financial Times* (February 25, 1987), p. 14. ■

### WANTED

LOREN (LARRY) B. GARDNER  
First Secretary of SID (1962-1963)

Last known address: Puerto Rico in 1967. If anyone knows his current address or phone number, please advise SID Historian Bob Knepper (714/732-3532) so we can learn more about the early history of the Society.

## WE'RE TAKING A BATH SO YOU CAN CLEAN UP

Western  
Microtechnology  
has 3,000 Sharp  
16 x 1 Liquid Crystal  
Displays that we want to  
sell. Now.

Why? Well, a customer of ours had big plans that didn't come through and we're left holding the displays. (So to speak.)

As a result, we're liquidating all 3,000 Sharp 16 x 1 LCDs at a price that's about half of what you'd normally pay. And we're selling them in any lot size from ten to 3,000 pieces. But, when they're gone, so is this deal.

Get more information about this very special deal on a very good display. Call 1(800) MEGABIT while you can still clean up.

P.S. - To make this deal even easier, ask us for part number LM 16152.

WESTERN MICROTECHNOLOGY  
12900 Saratoga, Avenue  
Saratoga, California 95070



Circle no. 10

# Gun Control.

At Southwest Vacuum Devices we solve gun control problems. Prototypes. Research. Design. Manufacturing.

We sole source guns and gun components for top U.S. OEMs.

Short runs cost you money, time, productivity. That's an area in which we excel.

Use us as an extension of your own engineering and production facilities.

As a domestic supplier we are only overnight, not oceans apart.

For solutions to your gun control problems, call or write us today.

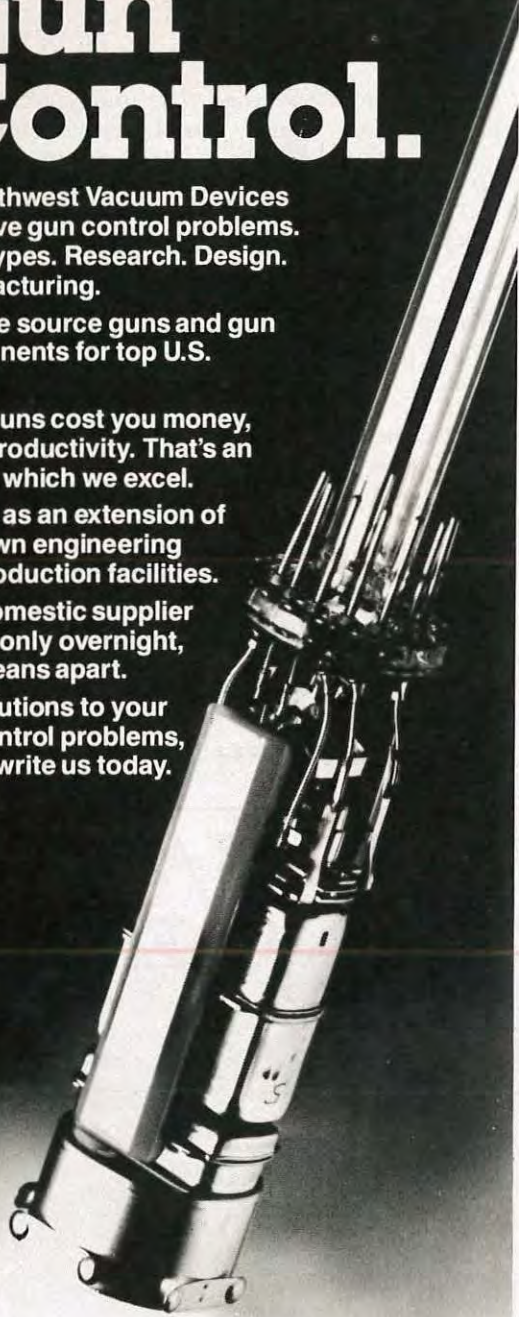

Complete Guns, Stems, Cathodes,  
Other Components



**SOUTHWEST VACUUM DEVICES, INC.**

P.O. Box 50524/Tucson, Arizona 85703  
(602) 887-7900 Telex 165-522

**A VIDEO DISPLAY COMPANY**

Circle no. 11

# SINGLE SOURCE



Whether it is a prototype, broadcast, TV, medical, newspaper or data display CRT—Video Display is the Nation's largest full line supplier of replacement tubes.

## SPECIALIZATION

VDC sells only CRTs, and has the most knowledgeable sales force in the industry. Supplying drop in replacements for any manufacturer's tube type is our specialty.

## QUALITY

VDC stocks CRTs featuring the latest dark glass, direct etch options in colors ranging from Black and White to European Amber. VDC replacement tubes are often of higher quality than the original tubes.

## INVENTORY

With over 70,000 units in stock, representing 3,000 tube types, VDC ships most orders the same day they are received.

## PRICING

No one sells the same high quality tubes for less. Not the OEMs, not other tube manufacturers, no one.

**1-800-241-5005**

**VIDEO DISPLAY  
CORPORATION**



5530 E Ponce De Leon Ave.  
Stone Mountain, Georgia 30086  
(404) 938-2080 or Your local VDC distributor

Circle no. 12



## Gray-scale ac plasma display

Thomson-CSF's TH 7621 ac plasma display panel with gray scale offers 8 luminance levels on each of its  $256 \times 512$  dots. Data input is by a digital video interface (RGB type, with clock and V and H sync.) for easy connection to microprocessor-based systems. Screen dimensions are  $208 \times 104$  mm, and dot spacing is 0.406 mm (equivalent to 62.5 lines/in.), providing good image definition.

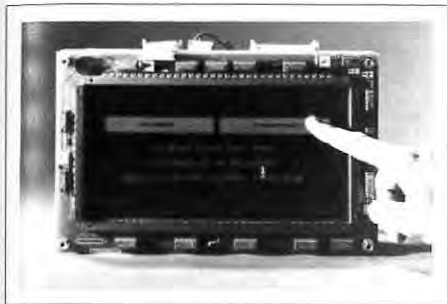

The TH 7621 has a viewing angle of  $>160^\circ$ , high contrast of  $>10$  under 1000 lux with etched filter, and rugged reliable construction. Power supply, interface (VT 220 or other), touch-input screen, and optical filter accessories are available.

For further information contact Thomson Electron Tubes and Devices Corp., 550 Mount Pleasant Ave., P.O. Box 6500, Dover, NJ 07801. 201/328-1400.

Circle no. 13

## Largest thinnest ac plasma display

Considered the world's largest ac plasma display, Magnavox Electronics Systems' MX 2116 has a viewable area of  $42 \times 42$  ft., and a high-resolution screen image defined by  $4.2 \times 10^6$  pixels. At only 6 in. thick—including the ac plasma panel, drivers, microprocessor controller, power supplies, and interface electronics—the MX 2116 requires one-fifth the space of typical projection systems, is compact and portable, and can be mounted on a wall or travel in a shock cradle.

Using a video interface, the display refreshes the full screen 30 times/sec flicker free. Using a graphic/alphanumeric interface, the system

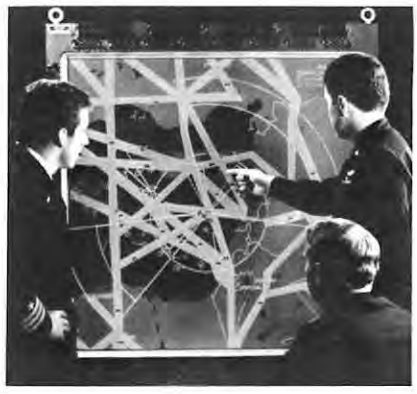

presents high-level graphics. Either input yields a high-resolution  $2048 \times 2048$  dot image on a monochrome screen decluttered with 4-16 levels of gray scale. Adjustable brightness and high contrast enhance image clarity in varied ambient light conditions.

The MX 2116 achieves a predicted MTBF of 7,500 hours and an MTTR of less than 5 min. All electronics are contained in modular assemblies; built-in test locates any problems, and any module can be replaced within 5 min. using an ordinary screwdriver.

For further information contact Patricia Perlini, Magnavox Electronic Systems Co., 1313 Production Rd., Fort Wayne, IN 46808. 219/429-7045.

Circle no. 14

## DCEL display

The Cherry Corp. introduces the first commercially available electroluminescent (DCEL) display panel offering high reliability and long life with a luminance of 25 fL with no more than 30% degradation at 10,000 hours life. The EL 1C-1000

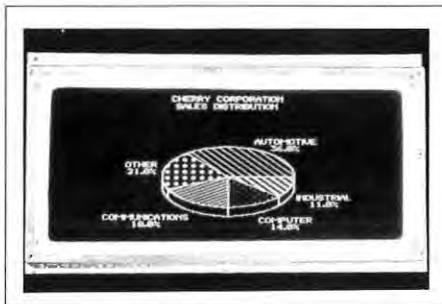

and EL 1C-G000 units have matrices of  $640 \times 200$ , with the EL 1C-1000 at a 2:1 aspect ratio and the EL 1C-G000 at a 1.4:1 aspect ratio. The width of the total package, including display and drivers, is less than 0.575 in. The new displays offer flicker-free imaging, high resolution, wide-viewing angles, uniform brightness, light weight, and durability. Cost in either configuration is \$800 for single piece quantities, \$385 at 5,000 pieces and \$250 in large volume.

For further information contact Eric J. Olson, The Cherry Corp., 3600 Sunset Ave., Waukegan, IL 60087. 312/360-3522.

Circle no. 15

## Intelligent alphanumeric displays

Hewlett-Packard Co. introduces two low-priced intelligent 8-character alphanumeric displays featuring a  $5 \times 7$  dot-matrix font. Contained in standard 0.6-in. dual-in-line 28-pin packages, the displays are available in yellow (HDSP-2111) and high-efficiency red (HDSP-2112). An on-board CMOS IC allows for low power consumption while providing the complete 128 ASCII character set. There are also 16 user-definable characters capable of generating foreign characters, special symbols, and logos.

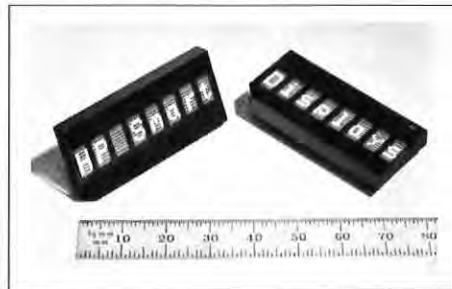

Additional features include an ability to blink individual characters in the 8-character string and to blink the full display. Requiring only a single 5-V power supply, the HDSP-2111 and 2112 are fully TTL compatible. For quantities of 1 to 99, unit price is \$42.

For further information call the Hewlett-Packard Co. sales office listed in the white pages telephone directory.

Circle no. 16

### LCD modules for broad temperature operation

UCE's new HR product line of LCD modules combines optimum backlighting for all light ambients with the new UCE optical heater to bring the LCD to optimum operating temperatures. The HR digital, analog, and combination modules include LCD with drivers, optically clear heater with controls, and backlighting. UCE also customizes display modules of



other manufacturers having EL or light-pipe backlighting by using the UCE "opti-clear" heater. This capability allows users to optimize existing designs to meet tough environmental specifications within minimum time and cost limits.

For further information contact UCE, Inc., 24 Fitch St., Norwalk, CT 06855. 203/838-7509.

Circle no. 17

### Panel-mounted LCD monitor

Communications and Display Systems announces the availability of a space-saving alphanumeric/graphic panel-mounted LCD monitor. The CDS 500-2P is designed for applications requiring high-density readouts, graphic presentations, and flexible display formats in an ultra-

thin package. The CDS 500-2P is mounted in a standard 5-1/4 x 19 in. rack panel with a system depth of 2 in. The LCD features the latest supertwist technology which offers high-contrast and wide-viewing-angle characteristics. An optional white EL backlit version, the CDS 500-2PE, is also available for low lighting conditions. Interface to the monitor is ac-

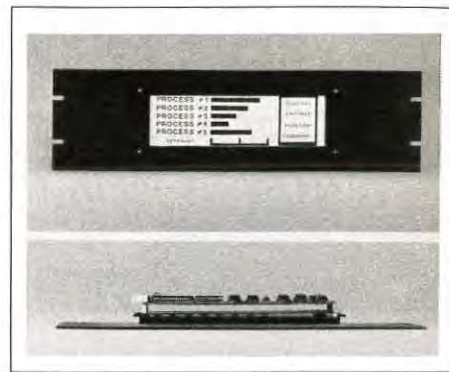

# Compact. Remote. Resolution.



## new products

reduced glare. The ZCM-1490 is designed to support the high-resolution video output generated by IBM's Personal System/2 computers and comparable video cards such as Zenith's new Z-449; the Flat Technology Monitor supports CGA, MDA, Hercules and EGA software on the Zenith Z-449 card. Resolution is  $640 \times 480$  pixels, and the device operates with a horizontal scan frequency of 31.5 kHz. The dot pitch is 0.31 mm and brightness output is rated at 75 fL. The brightness and contrast controls are conveniently located on top.

The ZCM-1490 includes an IBM Personal System/2 compatible 15-pin cable connector. The unit weighs about 40 lbs. and measures  $12.25 \times 14.75 \times 15.5$  in. Unit price is \$999.

For further information contact Zenith Data Systems, 1000 Milwaukee Ave., Glenview, IL 60025. 800/842-9000, ext. 1. **Circle no. 21**

### Penetration color CRT

Thomson-CSF's Electron Tube Division has developed a high-resolution 1-in. ruggedized micro-CRT with a penetration phosphor screen emitting from red to green. The tube assembly has an integral deflection system and high-voltage electrostatic focusing in a potted assembly 100 mm in length and 26 mm max. in diameter, with integral mu-metal



shielding, deflection yokes, socket and high-voltage leads. The TH X2615 E33 has an electrostatic focus gun and fine phosphor grain which gives 10,000-cd/m<sup>2</sup> peak line brightness, and 35- $\mu$ m linewidth (green). In night-vision TV scan (625 lines/50 Hz), the limiting center resolution is 900 (red) and 1300 (green) TV points with 150 cd/m<sup>2</sup> area brightness.

For further information contact Thomson Electron Tubes and Devices Corp., 550 Mount Pleasant Ave., P.O. Box 6500, Dover, NJ 07801. 201/328-1400.

**Circle no. 22**

### 7- and 5-in. projection CRTs

Thomson-CSF's 7-in. TH 8452 and 5-in. TH 8451 projection CRTs implement an all-electromagnetic 45-kV tetrode gun with dispenser cathode. The use of a dispenser cathode and fine-grain dense phosphors results in a high level of luminance/resolution compromise. The dispenser cathode allows the beam current to be doubled, while offering a significantly improved lifetime. Typical values are 95,000-cd/m<sup>2</sup> peak luminance with 85- $\mu$ m linewidth in trace scanning and 60,000-cd/m<sup>2</sup> screen luminance in the TH 8452. The TH 8451 has values of 75,000 cd/m<sup>2</sup> with 80- $\mu$ m linewidth in trace scanning, and 80,000-cd/m<sup>2</sup> screen luminance in TV scanning.



For further information contact Thomson Electron Tubes and Devices Corp., 550 Mount Pleasant Ave., P.O. Box 6500, Dover, NJ 07801. 201/328-1400.

**Circle no. 23**

### Electronic copyboard

The Quartet Ovonics Electronic Copyboard combines a new proprietary sensor technology with an erasable porcelain enamel-on-steel white board

## EMI CAN BE FOILED

with

### AD-MU-80 FOIL IN CUSTOMIZED SHAPES

High Permeability Shielding Alloy Foil in thicknesses of .002", .004", .006" and .010" can be fabricated by Ad-Vance Magnetics for your specific requirements.

- **CNC Punch Press Capability.**
- **AD-MU-80 Alloy requires no painting or plating.**
- **Tooling charge minimal, if any.**
- **Time saving and cost effective.**
- **Design assistance available.**

A small AD-MU Foil Shield may solve a large PROBLEM.



Gives major designing procuring guidelines. 2/3 of 84-page book contains valuable technical engineering information about the entire magnetic shielding field. 1/3 is catalog data. Yours for the asking.



## AD-VANCE MAGNETICS, INC.

The Problem Solving Magnetic Shielding Specialists

625 MONROE STREET, ROCHESTER, IN 46975  
(219) 223-3158 FAX 219-223-2524

**Circle no. 24**

which allows users to instantly produce letter- or full-sized copies of anything written on or attached to the board's surface. An electronic scanner feeds digital signals into a printer capable of producing up to 99 copies. The board can then be



erased and used again. The large highly durable scratch-resistant writing surface allows the user to copy any or all of the information posted. The copyboard is available in three models: a wall-mounted 44 x 66 in. board for \$3,495; a 33 x 66 in. reversible free-standing board on casters for \$3,695; and a 33 x 66 in. wall-mounted board for \$2,995.

For further information contact Quartet Manufacturing, 5700 Old Orchard Rd., Skokie, IL 60077. 312/965-0600.

Circle no. 25

### High-resolution low-cost video monitor

A new video monitor combining high resolution and low cost has been introduced by Video Monitors, Inc. A resolu-

tion of 1280 ppl makes this flicker-free M4000 work screen ideally suited for a variety of applications, including medical and research applications. The M4000 offers exceptional reliability (12,000 hours MTBF) and geometric precision (less than 2% major axis error). Monitors are available with 7-12 in. screens in vertical or horizontal formats, and weigh from 10

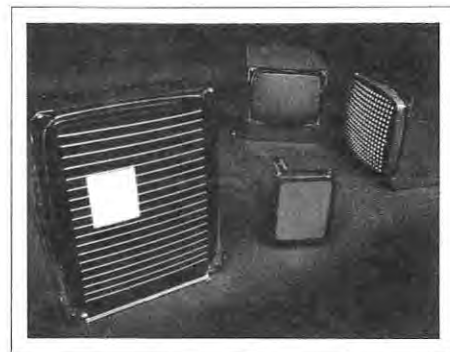

## MINOLTA METERS THE MEASURE OF EXCELLENCE

© 1987 Minolta Corporation

### FOR ACCURATE NON-CONTACT COLOR MEASUREMENT, NO OTHER METER COMES CLOSE.

Minolta's new CS-100 Chroma Meter achieves precision and comes close to everything else. Everything else, that is, in the way of light sources or surface colors that you might otherwise find difficult to measure.

Just point it and instantaneously read the luminance value of light sources or objects which are either too hot, too distant, too small, too inaccessible or for any reason simply not to be touched. Our spot colorimeter's built-in memory will also give you the difference between any two such sources or objects automatically.

And the CS-100 is just one of Minolta's full line of light and color measurement instruments. For more information, including our 21 page booklet "Precise Color Communications," please call (201) 825-4000 or write: Minolta Corporation Industrial Meter Division, 101 Williams Dr., Ramsey, New Jersey 07446.

When you need precise measurements, you just can't touch it. **ONLY FROM THE MIND OF MINOLTA.**

Circle no. 26



MINOLTA



## new products

to 21 lbs. List price of the monitor—complete with chassis and power supply—is under \$400 in OEM quantities. Models are also offered with custom-engineered chassis.

For further information contact Video Monitors, Inc., 3833 N. White Ave., Eau Claire, WI 54703. 715/834-7785.  
**Circle no. 27**

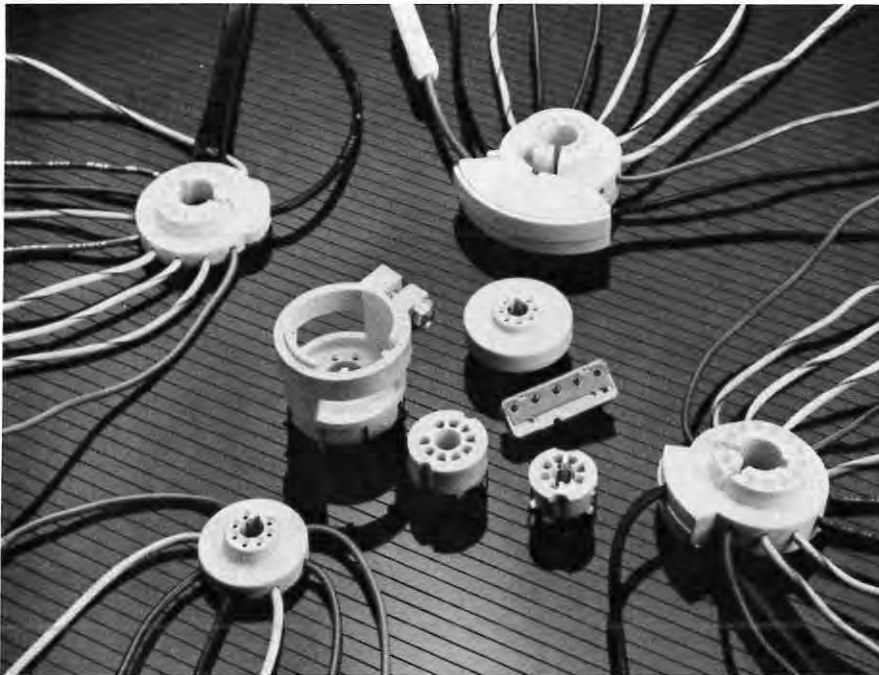

## CRT SOCKETS

*For high resolution Instrument and Information Displays*

### Quality features make quality CRT sockets . . .

The new *tube neck retaining clamp* feature is now available on most sockets. This integral retaining clamp insures that the tube and socket remain mated during extreme and rugged environmental conditions.

*Tapered lead-ins* of the insulator and the contact entry assures ease of tube base pin insertion. The tapers minimize contact deformation during insertion and help to retain the high contact forces originally designed into the contact.

Our *protective spark gaps* are designed and constructed to provide extremely reliable tube



and associated circuit component protection from voltage surges and overloads. These non-carbonizing air gaps are consistently dependable because there is no deterioration of the insulation surfaces or materials.

*Wrap-around contacts* with inherently high forces for low contact resistance between mating pin and receptacle are also an important feature of our sockets.

We *factory install* resistors, chokes and capacitors when needed.

*Customizing* existing sockets and *designing new* sockets to your specification is our speciality.

Call or write for our new Selection Guide 206 showing our full line of CRT sockets.

CRT courtesy of Clinton Electronics



*Innovators of Quality* **CONNECTOR CORPORATION** *American made Connectors*

**CONNECTOR CORPORATION**

6025 N. Keystone Avenue • Chicago, IL 60646-5290 • 312/539-3108 • TWX 910-221-6059

**Circle no. 29**

## Dual-pressure touch panels

Jayco Technology's DUALSCAN touch panels can be used wherever two-stage control sequences are required, enabling the user to scan by lightly touching the switches, and then to apply heavier pressure to activate the desired switch. Polyester tactile bubbles under the membrane provide audible clicks on selection and avoid fatigue problems associated with metallic-domed switches.

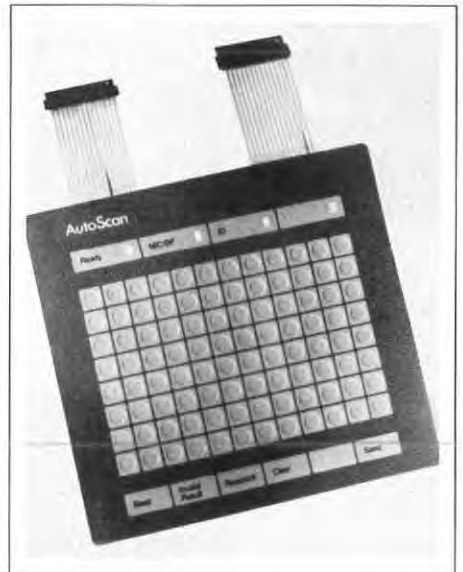

A standard range membrane switch panel is available comprising 4, 12, and 16 keypad units, in an xy matrix or common bus circuit. Designs can be any color, shape, or size and with any graphics. The panel surface can be flat or curved, and designs can be supplied with or without graphics overlays. Any key distribution can be accommodated and the switch area and legends can be illuminated. The panels are environmentally sealed, can be built into submersible equipment, and are suitable for operation in temperatures from  $-25^{\circ}\text{C}$  to  $+60^{\circ}\text{C}$ .

For further information contact British Information Services, 845 Third Ave., New York, NY 10022. 212/752-8400. ■

**Circle no. 28**

# GLASS

Seal rods and Spacer rods for flat displays.

Spacer rods made from float glass and other glasses. Any cross-section. Tolerances to suit.

Seal rods from Vitreous SG-90B. Seals at 465° C. Available in any cross-section.

Special glasses, redrawn tubing and rod. Sealing glasses. Special Glass-to-Metal seals. Sapphire-to-Metal seals. Creative solutions for technical glass problems.



APPLIED GLASS TECHNOLOGY, INC

2575 Sidney Lanier Drive  
Brunswick, Georgia 31520  
Telephone: 912-265-7386

Circle no. 31

# MICROVISION IS GROWING

If you would like to join a solid, rapidly growing display-oriented company as a sales / applications engineer, Microvision would like to hear from you.

We can offer a ground-floor opportunity with a company that is setting the standards for displays testing.

A technical support or sales engineer with an E.E. background from the SID community would be ideal. A strong commitment to customer support and satisfaction is required.

Submit your resume to Microvision, 4855 Atherton Avenue, Suite 201, San Jose, CA 95130. All resumes will be handled in strict confidence.

Circle no. 32

## MAKE FAST, COMPREHENSIVE, AUTOMATIC CRT MEASUREMENTS WITH THE SUPERSPOT 100 FROM MICROVISION

### CRT MEASUREMENT SYSTEM

The **SUPERSPOT 100** System coupled with the **SPOTSEEKER II** Positioning System (with Automatic Focus) allows fully automatic characterization of Color and Monochrome CRT Displays without operator intervention.

Measures:

- Luminance (Footlamberts & Nits) • Line Width, Including Color Line Width (Gaussian Fit) (1 Second)
- Color Misconvergence (2 Seconds) • Linearity, Pincushion and Focus • Line Jitter, Swim and Drift
- Contour Maps of Spots, Lines or Characters (10 Seconds) • Beam Landing & Crowding
- FFT for Discrete Frequency Spectra (1024 points in one second) • High Voltage Regulation Tests
- Real Time Display of Beam Intensity Profile (20 Frames/Second Display) • Disk Data Logging • MTF

Provides:

- Pattern Generation for Tests • Adjustable Cursors for Feature Analysis



MICROVISION • 4855 Atherton Avenue • Suite 201 • San Jose, CA 95130 • Tel: 408/374-3158 • FAX: 408/374-9394

Circle no. 33

## Bay Area Chapter

**Dean Church** was the guest speaker at the May 26 meeting of the Bay Area Chapter. Mr. Church gave an interesting presentation on "High-Resolution Graphics Displays vs. Imaging Displays." Mr. Church is the director of product marketing for the **Ramtek Corp.**

## Greater Dayton Chapter

The Greater Dayton Chapter members welcomed **Richard Holmes** of **Electronic Image Systems** to the May 4 meeting. Mr. Holmes presented a paper on a "Large-Screen Color Projection System with Digital Correction." Mr. Holmes has also been elected the Greater Dayton Chapter's National SID Representative.

## Los Angeles Chapter

**Pat Henry** of **Pantec** brought a working model of the Philips MEL flat CRT to the Los Angeles Chapter's June 24 meeting. In addition to discussing the design and applications of the Philips MEL, Mr. Henry also shared his thoughts on the future of large, flat color CRTs. A summary of SID '87 flat-panel papers and developments in EL, LCD, plasma, and VFD technologies was also presented.

Several interesting presentations were given at the May 27 Los Angeles Chapter meeting. **T. Nishino** of **Sony Corp.** and

**Dave Eccles** of **Hughes Ground Systems Group** discussed the design and performance of Sony's 20 x 20 in., 2000 x 2000 pixel Trinitron color monitor, and gave a demonstration of the hardware as driven with a computer-controlled video generator. **Dave Eccles** and **Keith Hanson** also gave a summary of events at SID '87. **Ralph Wilhelm Jr.** of **Delco Electronics** shared his slides of past, present, and future automotive displays from his SID '87 keynote address.

**Larry Tannas** of **Tannas Electronics** spoke on "3-Dimensional Displays" at the April 19 joint meeting with IEEE.

## Mid-Atlantic Chapter

The Mid-Atlantic Chapter proudly announces the unanimous election of its 1987-1988 officers: Chairman, **Terry Nelson**; Vice-Chairman, **Douglas Ketchum**; Secretary, **Eugenio Segredo**; and Treasurer, **Hiap L. Ong**.

The Chapter owes a debt of gratitude to **Ron Feigenblatt** for his energetic and imaginative leadership as outgoing Chairman, and looks forward to an exciting year under Terry Nelson's leadership.

## Minneapolis-St. Paul Chapter

**Brad Hartig** of **Unisys Corp.** was the guest speaker at the Minneapolis-St. Paul Chapter's April 24 meeting. Mr. Hartig, a

marketing sales representative for Unisys, spoke on a "Voice Controller Terminal."

## UK and Ireland Chapter

The UK and Ireland Chapter's May 20 meeting was held jointly with the IEE Professional Groups E5 and E14. Presentations included "LCDs for TV" by **John White** of **Thorn EMI**; "CRT Displays" by **Alan Knapp** of **Philips, UK**; "The Indextron: A New High Brightness Color Image Display Tube" by **Gareth Price** of **Sony, UK**; "Projection Displays" by **Terry Doyle** of **Philips, Netherlands**; and "Direct View Stereo" by **John Turner** of the **University of Essex**.

On July 6 and 7, the UK and Ireland Chapter held a two-day Residential Symposium on Color Displays in association with the University of Durham. Speakers included **David Healy** of **IBM** on "What the Market Wants"; **Keith Ruddock** of the **Imperial College** on "Color Vision"; **Bernard Green** of **Thorn EMI** on "Color in LCDs"; **Malcom Highton** of **Phosphor Products** on "Color EL Displays"; **Derek Washington** of **Philips** on "Color in Flat CRTs"; and **Peter Philips** of **British Aerospace** on "Optimizing the Use of Color." The gathering also discussed events at SID '87.

Future meetings include:

**Sept. 15-17**, EuroDisplay '87, Savoy Place, London

**Nov. 10**, CRT Displays and 1987 AGM, Hammersmith, London ■



## August

**Computer Art and Design Conference.** Bob Cramblitt/Nancy Flower, NCGA, 2722 Merrilee Dr., Suite 200, Fairfax, VA 22031. 703/698-9600.

Aug. 10-14 Chicago, IL

**Second International Conference on Human-Computer Interaction.** Gabriel Salvendy, School of Industrial Engineering, Purdue Univ., Lafayette, IN 47907. Aug. 10-15 Honolulu, HI

**SPIE 31st Annual International Technical Symposium on Optical and Electro-Optical Engineering/Exhibit.** SPIE, P.O. Box 10, Bellingham, WA 98227-0010. 206/676-3290.

Aug. 16-21 San Diego, CA

**NCGA CAD/CAM '87.** Bob Cramblitt/Nancy Flower, NCGA, 2722 Merrilee Dr., Suite 200, Fairfax, VA 22031. 703/698-9600.

Aug. 17-20 Boston, MA

**COMDEX/Australia.** The Interface Group, Inc., 300 First Ave., Needham, MA 02194. 617/449-6600.

Aug. 19-21 Sydney, Australia

**14th Congress of the International Commission for Optics.** SPIE, P.O. Box 10, Bellingham, WA 98227-0010. 206/676-3290.

Aug. 24-28 Toronto, Canada

**Second Pan Pacific Computer Conference on Information Technology: Emerging Opportunities and Challenges.** Herbert B. Safford, GTE Data Service, 4750 Lincoln Blvd., Marina del Rey, CA 90292. 213/821-0511, ext. 355.

Aug. 26-29 Singapore

**Symposium on Business and Marketing Issues in Photography and Electronic Imaging.** Conference Manager, SPSE, 7003 Kilworth La., Springfield, VA 22151. 703/642-9090.

Aug. 31-Sept. 2 New York, NY

*Editor's Note: Short courses appear at the end of the calendar.*

## September

**WELDEX '87: International Welding, Cutting and Metal Fabrication Exposition.** British Information Services, 845 Third Ave., New York, NY 10022. 212/752-8400.

Sept. 14-18 Birmingham, England

**ADEE East '87.** Cahners Exposition Group, 1350 E. Touhy Ave., P.O. Box 5060, Des Plaines, IL 60017-5060. 312/299-9311.

Sept. 15-17 Boston, MA

**Symposium on Environmental Issues in Photofinishing.** Pam Forness, SPSE, 7003 Kilworth La., Springfield, VA 22151. 703/642-9090.

Sept. 15-17 Los Angeles, CA

**Eurodisplay '87: Seventh International Display Research Conference.** Clive Jones, The Institute of Physics, 47 Belgrave Sq., London SW1X 8QX, U.K. 01-235-6111. In the U.S.: Palisades Institute for Research Services, Inc., 201 Varick St., New York, NY 10014. 212/620-3388.

Sept. 15-17 London, England

**DES '87: Design Engineering Show.** British Information Services, 845 Third Ave., New York, NY 10022. 212/752-8400.

Sept. 15-18 Birmingham, England

**Fourth Toner and Developer Industry Conference.** Diamond Research Corp., P.O. Box 128, Oak View, CA 93022. 805/649-2209.

Sept. 20-22 Santa Barbara, CA



Total in-house design, manufacturing,  
and testing capabilities

Magnetic shielding and shielding grade alloys  
of all types...

Send for our latest product literature

*Magnetic* **RADIATION  
LABORATORIES, INC.**

92-A North Lively Boulevard • Elk Grove Village, Illinois 60007  
Phone: 1-312-437-5200 • TWX 510-601-1013

Circle no. 35



## calendar

**NORTHCON '87 Electronics Show and Convention.** Dale Litherland, NORTHCON '87, 8110 Airport Blvd., Los Angeles, CA 90045. 213/772-2965. Sept. 22-24 Portland, OR

**TMI/East: Test, Measurement and Inspection for Quality Control/East.** Mary Jo McGuire, Tower Conference Management Co., 331 W. Wesley St., Wheaton, IL 60187. 312/668-8100. Sept. 22-24 Detroit, MI

### October

**ASIS 50th Annual Conference.** American Society for Information Science, P.O. Box 554, Ben Franklin Station, Washington, DC 20044. 202/462-1000. Oct. 4-8 Washington, DC

**COMPSAC '87.** Dr. Stephen S. Yau, Northwestern Univ., Dept. of EECS, Evanston, IL 60201. 312/491-3641. Oct. 5-9 Tokyo, Japan

**International Astronautical Congress.** Gloria W. Heath, Conference Coordinator, SAR-ASSIST, One Island La., Greenwich, CT 06830. 203/869-1322. Oct. 11-16 Brighton, England

**Seventh Gulf Computer Exhibition.** Sandra Royan/Abdullah Mohammed, Trade Center Management Co., P.O. Box 9292, Dubai, United Arab Emirates. 372200. Oct. 12-15 Dubai, UAR

**INTERCERAMEX '87: International Ceramic Plant Machinery and Supplies Exhibition.** British Information Services, 845 Third Ave., New York, NY 10022. 212/752-8400. Oct. 12-16 Stoke-On-Trent, England

**Newport Conference on Fiberoptic Markets.** June Warren, Kessler Marketing Intelligence, Americas Cup Ave. at 31 Bridge St., Newport, RI 02840. 401/849-6771. Oct. 14-15 Newport, RI

**Northeast Computer Faire.** The Interface Group, Inc., 300 First Ave., Needham, MA 02194. 617/449-6600. Oct. 15-17 Boston, MA

**Human Factors Society Annual Meeting.** Marian Knowles, Human Factors Society, P.O. Box 1369, Santa Monica, CA, 90406. 213/394-1811. Oct. 19-23 New York, NY

**Test and Transducer Exhibition.** Show Organizer, Trident International Exhibitions, 21 Plymouth Rd., Tavistock, Devon PL19 8AU, England. 01-822-4671. Oct. 20-22 London, England

**The Animation Festival Bristol 1987.** Irene Kotlarz, 41B Hornsey Lane Gardens, London N6 5NY, U.K. 01-341-5015. Oct. 22-Nov. 1 Bristol, England

**Cambridge Symposium on Optics in Medicine and Visual Image Processing.** SPIE, P.O. Box 10, Bellingham, WA 98227-0010. 206/676-3290. Oct. 25-30 Cambridge, MA

**Digital Image Processing and Visual Communications Technologies in Meteorology.** SPIE, P.O. Box 10, Bellingham, WA 98227-0010. 206/676-3290. Oct. 25-30 Cambridge, MA

**New Directions in Photodynamic Therapy.** SPIE, P.O. Box 10, Bellingham, WA 98227-0010. 206/676-3290. Oct. 25-30 Cambridge, MA

**National Database and Fourth Generation Language Symposium.** Mary E. Lownie, Digital Consulting Assoc., Inc., 6 Windsor St., Andover, MA 01810. 617/470-3870. Oct. 27-30 Dallas, TX

**Computer Communication for Developing Countries '87.** Dr. P. P. Gupta, CMC Ltd., 1 Ring Rd., Kilokri Opp. Maharani Bagh, New Delhi, India. 631699, 635086, 630827. Oct. 27-30 New Delhi, India

**The Artificial Intelligence and Advanced Computer Technology Conference and Exhibition.** Tower Conference Management, 331 W. Wesley St., Wheaton, IL 60187. 312/668-8100. Oct. 28-30 Atlantic City, NJ

### Short Courses

**Information Display Systems Engineering—Short Course.** (Larry Tannas, Instructor) P.O. Box 24901, Dept. K, UCLA Extension, Los Angeles, CA 90024. 213/825-3344. Aug. 3-7 Los Angeles, CA

**Human Factors Engineering Summer Conferences—Short Course.** 400 Chrysler Center, North Campus, Univ. of Michigan, Ann Arbor, MI 48109. 313/764-8490. Aug. 3-14 Ann Arbor, MI

**Computer Graphics: A Comprehensive Introduction—Short Course.** Marilyn Martin, Integrated Computer Systems, 5800 Hannum Ave., P.O. Box 3614, Culver City, CA 90231-3614. 213/417-8888. Aug. 4-7 Washington, DC  
Sept. 15-18 Palo Alto, CA  
Oct. 27-30 Los Angeles, CA

**Extending the Human Mind: Computers in Education—Short Course.** Computers in Education, Univ. of Oregon Continuation Center, 1553 Moss St., Eugene, OR 97403. 503/686-3537. Aug. 6-7 Eugene, OR

**Hands-On Graphics Programming Using GKS/VDI Tools—Short Course.** Marilyn Martin, Integrated Computer Systems, 5800 Hannum Ave., P.O. Box 3614, Culver City, CA 90231-3614. 213/417-8888. Aug. 11-14 San Diego, CA  
Aug. 18-21 Washington DC  
Oct. 6-9 Los Angeles, CA  
Oct. 27-30 Boston, MA

**Fiber Optic Communications—Short Course.** Marilyn Martin, Integrated Computer Systems, 5800 Hannum Ave., P.O. Box 3614, Culver City, CA, 90231-3614. 800/421-8166. Aug. 11-14 Boston, MA  
Aug. 25-28 San Francisco, CA  
Sept. 15-18 Washington, DC

**Digital Image Processing—Short Course.** Marilyn Martin, Integrated Computer Systems, 5800 Hannum Ave., P.O. Box

3614, Culver City, CA 90231-3614.  
800/421-8166.

Aug. 18-21 Anaheim, CA  
Sept. 15-18 Washington, DC  
Sept. 22-25 San Diego, CA

**Machine Vision and Image Recognition—Short Course.** Integrated Computer Systems, 5800 Hannum Ave., P.O. Box 3614, Culver City, CA 90231-3614. 213/417-8888.

Sept. 15-18 Los Angeles, CA  
Sept. 29-Oct. 2 Washington, DC  
Oct. 20-23 Anaheim, CA

**Computer and Communications Security—Short Course.** Tom Watson, Integrated Computer Systems, 5800 Hannum Ave., P.O. Box 3614, Culver City, CA 90231-3614. 213/417-8888.  
Oct. 20-23 Anaheim, CA

## Call for Papers

**Ninth International Conference on Pattern Recognition.** Oct. 17-20, 1988, Beijing, China. Papers are solicited for, but not restricted to, the following areas: computer vision and image understanding; robot and machine vision; image segmentation and edge detection; shape and texture analysis; optic flow and stereovision; knowledge-based pattern recognition systems; feature selection and pattern classification; motion representation and analysis; modeling of human perception; image data structures and image coding; speech and signal processing; character recognition and text processing; parallel algorithms and architectures; industrial applications; biomedical applications; and remote sensing and other applications. Papers must be typewritten in English and double-spaced. Title page must contain all authors' names and addresses, and a 70-

to 100-word abstract. Four copies should be sent to Prof. Herbert Freeman, 9ICPR Chairman, CAIP Center, Busch Campus, Rutgers Univ., New Brunswick, NJ 08903. 201/932-3443.  
Deadline for abstracts: Dec. 2

**The Society for Information Display 1988 International Symposium, Seminar and Exhibition.** May 23-27, Anaheim, CA. Papers are solicited in the following areas: emissive and non-emissive flat panels; CRT displays; hard copy/printers; display systems and applications; automotive displays; display addressing/packaging; interactive I/O technology; human factors; large-area displays; workstations; and avionic displays. For a copy of the Call for Papers, contact the Society for Information Display, c/o Palisades Institute for Research Services, Inc., 201 Varick St., Rm. 1140, New York, NY 10014. 212/620-3388.  
Deadline for abstracts: Dec. 7 ■

**We Cover The Spectrum in CRT's**

... from concept to complete tube. We also offer custom lamination of a wide range of filters and EMI panels to your tubes or ours.

Do you need electroluminescent targets for research or for production equipment? We will apply the phosphor screen of your choice to any glass or metal target.

**GRT SCIENTIFIC CORPORATION**

14746 Raymer Street • Van Nuys, California 91405  
(818) 989-4610 • (213) 873-5107

Circle no. 34

# Call for nominations of candidates for the 1988 SID honors and awards

The SID Honors and Awards Committee is soliciting your help in nominating qualified candidates for Fellow, for the Karl Ferdinand Braun and Johann Gutenberg Prizes, and for its other awards. General qualifications based on the SID bylaw requirements for honors and awards are given below.

## FELLOW

The grade of Fellow is one of unusual professional distinction conferred by the Board of Directors, acting on the recommendation of the Honors and Awards Committee, upon a SID member of outstanding qualifications and experience as a scientist or engineer in the field of information display. The candidate shall have been a member of the Society for five years and shall have made a widely recognized and significant contribution to the advancement of the field. The nomination must be supported and signed by at least five members in good standing.

## KARL FERDINAND BRAUN PRIZE

The Karl Ferdinand Braun Prize is awarded for an outstanding *technical* achievement in, or contribution to, display technology. The award is made by the Board of Directors acting on the recommendation of the Honors and Awards Committee and carries a stipend of \$2000.

## JOHANN GUTENBERG PRIZE

The Johann Gutenberg Prize is awarded for an outstanding *technical* achievement in, or contribution to, printer technology. The award is made by the Board of Directors acting on the recommendation of the Honors and Awards Committee and carries a stipend of \$2000.

## BEATRICE WINNER AWARD

The Beatrice Winner Award for Distinguished Service to SID is awarded periodically, but not more than once each year, to a Society member for exceptional and sustained service to SID. The award is made by the Board of Directors acting on the recommendation of the Honors and Awards Committee.

## SPECIAL RECOGNITION AWARDS

Special citation awards are given to members of the technical and scientific community, not necessarily SID members, for distinguished and valued contributions to the information display field. These awards may be made for contributions in one or more of the following categories:

a. Outstanding technical accomplishments.

b. Outstanding contributions to the literature.

c. Outstanding service to the Society.

Nominations should comply with the 1987 Guidelines for SID Honors and Awards Nominations, and they should be submitted to the Honors and Awards Committee Chairman no later than **October 1, 1987.**

## Guidelines for SID Honors and Awards Nominations

Nominations for SID Honors and Awards should be concise, but they must include the following information, preferably in the order given below.

1. Name, Present Occupation, Business and Home Address, and SID Membership Grade (Member or Fellow) of Nominee.

2. Award being recommended:  
Fellow\*

Karl Ferdinand Braun Prize  
Johann Gutenberg Prize  
Beatrice Winner  
Special Recognition

\*Fellow nominations must be supported and signed by at least five SID members.

3. Proposed Citation. This should not exceed 30 words.

4. Name, Address, Telephone Number, and SID Membership Grade of Nominator.

5. Education and Professional History of Candidate. Include college and/or university degrees, positions and responsibilities of each professional employment.

6. Professional Awards and Other Professional Society Affiliations and Grades of Membership.

7. Specific statement by the nominator concerning the most significant achievement or achievements or outstanding technical leadership which

qualifies the candidate for the award.

This is the most important consideration for the awards committee, and it should be specific (citing references when necessary) and concise.

8. Supportive material. Cite specific evidence such as patents, publications, SID activities, other technical and/or professional society activities, evidence of outstanding leadership, etc. Please be specific and concise. Cite material that directly supports the citation and statement in (7) above. Limit the evidence to the most important patents, publications, or service—do not generalize. (The nominee may be asked by the nominator to supply information for his candidacy.)

9. References. Fellow nominations must be supported by the references indicated in (2) above. Supportive letters of reference will strengthen the nominations for any award.

Send the complete nomination—including all the above material—to the Honors and Awards Chairman by **October 1, 1987.**

Dr. Webster E. Howard, Chairman  
Honors and Awards Committee  
IBM T.J. Watson Research Center  
P.O. Box 218  
Yorktown Heights, NY 10598  
914/681-5620

# Sophisticated Display Solutions from Syntronic.

*Deflection Components  
to maximize the  
performance of  
your display!*

As your displays become increasingly complex, Syntronic yokes deliver the sophistication you need. Whether your challenge is a miniature display, military cockpit display, or a high resolution display, Syntronic Instruments will help you attain optimum display performance.

Syntronic is the largest custom designer and manufacturer of CRT deflection components in the industry. These sophisticated components include deflection yokes, focus coils, beam alignment and beam shaping coils, micrometer-controlled alignment devices and related CRT mounting devices. Syntronic deflection components offer the sophistication you need.

When you need ultimate performance from your display, sophisticated deflection components from Syntronic Instruments are the answer!



## **syntronic**

**Syntronic Instruments, Inc.**  
100 Industrial Road  
Addison, IL 60101  
Phone (312) 543-6444

Circle no. 30

# CHALLENGING OPPORTUNITIES

Dedicate your career to an expanding, leading manufacturer of special purpose cathode ray tubes (CRTs).

To meet these expanding requirements, we are seeking professionals in two areas:

**Senior Chemist** to develop and refine processes for phosphor, lacquering and aluminizing high resolution CRTs. BS in chemistry and several years of related experience desirable.

**Design Engineer** to be involved in the development and design of electron guns for the manufacturing of special purpose CRTs. BS in ME or EE with 3-5 years experience desirable.

We offer competitive salaries with an excellent benefits package.

Send resume, in confidence, to E. Markant, Personnel Director.

THOMAS ELECTRONICS, INC.  
100 RIVERVIEW DR., WAYNE, NJ 07470

Circle no. 36

## Wanted . . . Your Ad for ID Classified

Starting in September, ID Classified will list job openings, positions wanted, consultants, and business opportunities. Here is an economical way to get your message across to ID's 10,000+ readers.

### How to place your ad

Please type or neatly print your copy, indicating headlines and text. Indicate what months you want ad to run. Include your name, address, and daytime phone number.

**Rates:** \$55 per column-inch (minimum)  
\$10 per each additional line

### Size:

One column-inch = 10 lines text without heading OR  
8 lines text with 1-line large heading OR  
6 lines of text with 2-line heading

each line of text = approximately 7 words  
each line of heading = maximum 20 characters  
each line of heading takes up 2 lines of text

**Deadline:** First of the month prior to issue date (i.e. August 1 for the September issue)

**Payment:** Minimum payment of \$55 must accompany order.

Send your ad to: **ID Classified, c/o Palisades Institute**  
201 Varick St., Suite 1140, New York, NY 10014

## index to advertisers

	Page
AEG Corp. ....	C3
Ad-Vance Magnetics. ....	26
Applied Glass Technology. ....	29
CELCO ....	C4
CRT Scientific Corp. ....	33
Connector Corp. ....	28
Eurodisplay '87. ....	20
Hughes Aircraft Co. ....	4
Litton Electron Devices. ....	9
Magnetic Radiation Laboratories. ....	31
Microvision ....	29
Minolta Corp. ....	8, 27
Panasonic Industrial Co. ....	1
Photo Research SpectraMetrics. ....	2
Quantum Data. ....	C2
Southwest Vacuum Devices. ....	22
Syntronic Instruments. ....	35
TEAM Systems. ....	6
Thomas Electronics. ....	36
Video Display Corp. ....	22
Western Microtechnology. ....	21
Westinghouse Electric Corp. ....	24, 25

### Business Office

Palisades Institute for  
Research Services, Inc.  
201 Varick Street, Suite 1140  
New York, NY 10014  
Jay Morreale, Advertising Mgr.  
212/620-3371

### Sales Office—Western States

Ted Lucas  
P.O. Box 852  
Cedar Glen, CA 92321  
714/337-6627

## Calling all artists

ID's editors are calling on its talented readers to lighten and brighten the magazine. We are looking for humorous drawings and cartoons on the lighter side of information display. ID will pay \$25 for each submission used.

Send original black-and-white pen-and-ink drawings to: Lynne A. Henderson, "Light Byte" Editor, Information Display, c/o Palisades Institute for Research Services, Inc., 201 Varick St., Rm. 1140, New York, NY 10014. Please enclose a stamped self-addressed envelope for the return of your artwork.



**High resolution, rugged CRT's for avionics ... a brighter idea from AEG!**

The new color display tube from AEG, the M18-E851, is specifically designed to meet the needs found in avionics applications.

This new rugged assembly is quite at home in the relatively harsh environmental confines of a high performance aircraft cockpit.

The CRT achieves its high resolution via the use of a fine 0.2mm pitch shadow mask and a very rugged in-line electron gun.

Assembly technology for the very bright 5" x 5" display includes a self-converging deflection system, static color purity with convergence correction and an effective contrast enhancement filter. All of these innovations result from the many years of AEG leadership and experience in tube technology for avionics.

AEG is a world wide source for technological innovation in areas which include not only technical tubes for avionics but information systems, electronic packaging, power semiconductors, robotics and office systems, to name a few.

For more information on our high resolution color CRT's or on any of our other high technology products, contact:

AEG Corporation  
Route 22-Orr Drive  
PO Box 3800  
Somerville, NJ 08876-1269  
or call (201) 722-9800.

**AEG**



# Celco *Micro* Color Film Recorder

## 35mm Slide Production



The CELCO *Micro* Color Film Recorder is the 35mm workhorse of the computer graphics industry.

- Business Graphics
- Rugged design
- 24 hr./day continuous operation
- Low cost
- Compact size
- Fast film recording speed:
  - Less than 1 minute for a complex 35mm slide
- Excellent image quality
- Precise addressability: 8192 x 8192
- Full tonal imagery: 68 billion addressable colors
- Optional CELCO Control Software

CELCO introduces the 35mm workhorse to meet the rigorous demands of volume producers of high-quality business graphics.

The CELCO *Micro* 35mm Color Film Recorder features fast film recording and excellent quality graphics. Colors are bright and rich.

Also featuring low cost, compact size and rugged design, the CELCO *Micro* is built to yield unprecedented reliability.

CELCO *Micro* saves time and makes money for producers of 35mm slides.

#### OPTIONAL CELCO CONTROL SOFTWARE

- Plotting control
- File handling
- Complete diagnostic and calibration routines
- Job Control Block (JCB) for animation files handling

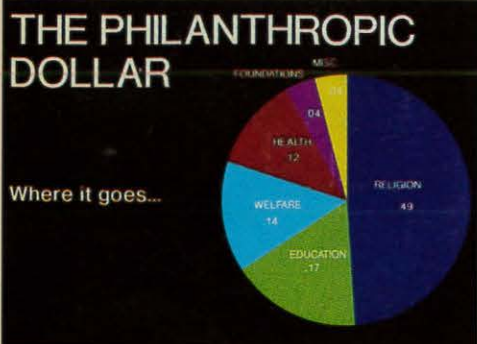

Service bureau business graphics. Data courtesy MAGI/MAGICorp.

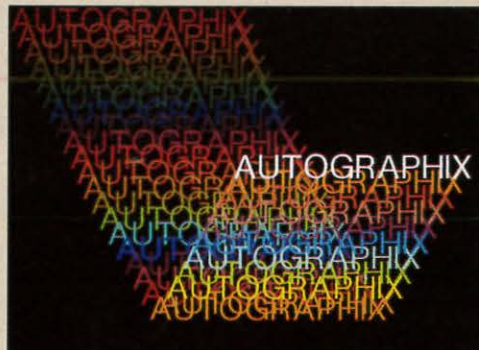

CELCO *Micro* saves time and money for volume producers of high quality business graphics. Data courtesy Autographix.



"Sexy Robot"  
Data courtesy Ketchum Advertising for Abel Image Research, Hollywood, CA.

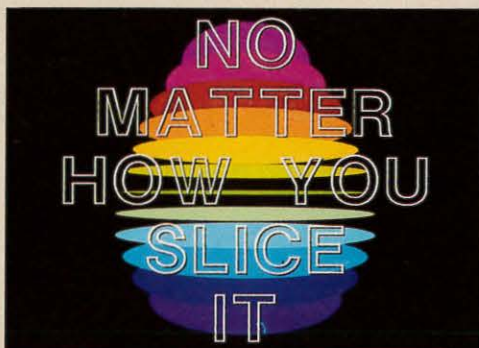

"No matter how you slice it," you never get a lemon.  
Data courtesy Management Graphics

For more information, call CELCO today.

CELCO-Constantine Engineering Labs, Co.  
70 Constantine Drive, Mahwah, NJ 07430  
201-327-1123

CELCO, Pacific  
1150 E. Eighth Street, Upland, CA 91786  
714-985-9868